

ShipModul

Marine Electronics

MiniPlex-3PRO NMEA 0183/2000 multiplexer Manual



MiniPlex-3PRO
Firmware V3.4.x

© ShipModul B.V. 2021

Introduction	7
NMEA 0183 Ports	7
<i>NMEA 0183 Signals</i>	7
<i>NMEA 0183 Inputs</i>	7
<i>NMEA 0183 Outputs</i>	8
<i>Connecting to other devices</i>	8
<i>Combining Ports</i>	9
NMEA 2000 Port	10
Ethernet Port	11
1. Existing network/router with DHCP.....	11
2. Existing network with static IP addresses/no DHCP.....	11
3. Direct connection to a computer.....	12
<i>Network Setup</i>	12
UDP Mode: Directed.....	13
TCP.....	13
Port Number.....	13
Saving the Network Setup.....	13
Reset to DHCP.....	13
<i>Network Recovery</i>	14
Network Basics	15
<i>IP Address</i>	15
<i>Network Mask</i>	15
<i>Port Number</i>	15
<i>Assigning IP addresses/DHCP</i>	16
Auto-IP.....	16
<i>Protocols</i>	16
UDP Broadcast.....	16
UDP Directed.....	17
TCP.....	17
SeaTalk	18
<i>Conversions from SeaTalk to NMEA</i>	18
<i>Conversions from NMEA 0183/2000 to SeaTalk</i>	18
Example.....	19
NMEA 2000	20
<i>Devices and Virtual Devices</i>	20
Protocol Conversions	21
NMEA 0183 and SeaTalk to NMEA 2000.....	21
NMEA 2000 to NMEA 0183.....	21
NMEA 2000 and NMEA 0183 to SeaTalk.....	21
SeaTalk to NMEA 0183.....	22
NMEA 2000 and SeaTalk in the Routing Table.....	22
Power Supply	23
Indicators	23

Data Throughput	23
MPXConfig3Pro	25
Menu.....	26
MiniPlex Connection.....	27
UDP All.....	27
Reading the configuration.....	27
Multiplexer does not respond.....	27
Connect timed out.....	27
Socket Error # 10061, Connection refused.....	27
Send NMEA.....	27
View Options.....	28
Clear.....	28
No Scroll.....	28
Tag Blocks.....	28
Input selector.....	28
Overflow.....	28
NMEA Inputs/Outputs.....	29
Input Settings.....	29
Speed.....	29
Talker ID.....	29
Priority.....	30
GPS.....	31
AIS.....	31
Input Mode.....	31
Input "NMEA Conversions".....	32
Input "NMEA 2000".....	32
Default Route.....	32
Output Settings.....	32
Speed.....	32
Host Data.....	32
Output NMEA V1.5.....	33
Ignore Divisor.....	33
Priority Control.....	33
Options.....	34
General Options.....	34
AIS Own Position to GPS data.....	34
Modbus.....	34
Raw SeaTalk (PSMDST).....	34
SeaTalk Depth in meters.....	34
Suppress Pinning.....	35
TAG Blocks.....	35
Unique ID.....	35
NMEA 0183 Generation from NMEA 2000 and SeaTalk.....	35
10 Hz.....	35
System Time - ZDA/PGN 126992.....	35
VBW/VHW (Speed) at 10 Hz.....	36
Attitude.....	36
Depth.....	36
True heading.....	36
Conversions.....	37
Heading.....	37
Heading Magnetic \leftrightarrow True (HDG/HDM \leftrightarrow HDT).....	37
Reverse Heading (HDM/HDG/HDT/THS).....	37
COG to True Heading (VTG \rightarrow HDT).....	38
HDT \leftrightarrow THS.....	38
Speed.....	38
GPS Speed to Log Speed (VTG \rightarrow VHW).....	38

Log Speed to GPS Speed (VHW → VTG).....	38
Reverse Speed (VBW).....	38
Combine Heading and Speed into VHW.....	38
Wind.....	38
VWR ↔ MWV.....	38
Apparent to True Wind (MWV,R → MWV,T).....	38
Calculate Wind Direction (MWV,T → MWD).....	38
Reverse Wind Angle (MWV).....	39
<i>Routing</i>	40
Routing Table Columns.....	40
Table Buttons and Controls.....	41
Editing the table.....	41
Note on editing tables.....	41
Filling the table.....	41
NMEA 2000 Sources.....	42
Routing Operation.....	42
Example.....	43
<i>NMEA 2000</i>	44
Device Settings.....	44
Device Type.....	44
SA (Source Address).....	45
Setting a Source Address.....	45
DI (Device Instance).....	45
Generate \$MXPGN.....	46
From unknown PGNs.....	46
From all PGNs.....	46
Device List.....	46
Source Address.....	47
Device Instance.....	47
System Instance.....	48
<i>Modbus</i>	49
Modbus Table Columns.....	49
Modbus Slave Addresses.....	50
Register Order.....	50
Precision.....	50
Slave Status.....	50
Communication Parameters.....	50
Diagnostics.....	50
Firmware Update	51
<i>Procedure</i>	51
Mounting	52
Technical Reference	53
<i>NMEA 0183 Glossary</i>	53
Talker ID's.....	53
Sentence formatters.....	53
<i>Supported NMEA 2000 PGN list</i>	55
<i>Conversions from NMEA 2000 to NMEA 0183</i>	56
<i>Conversions from NMEA 2000 to NMEA 0183 XDR sentences</i>	58
Engine data.....	58
Generic sensor data.....	58
Meteorological data.....	59
<i>Conversions from NMEA 0183 to NMEA 2000</i>	60
<i>Converted SeaTalk Datagrams</i>	62

<i>Firmware Update Error messages</i>	64
The firmware update failed	64
Not a valid firmware file.....	64
Unsupported firmware file version.....	64
Firmware file is corrupt.....	64
The version of the firmware file is lower than the version of the multiplexer. Do you really want to proceed?	64
Bootloader initialisation failed.....	64
Firmware file does not match with the multiplexer type	64
Bootloader: Erase command timeout.....	64
Bootloader: Encryption command timeout	64
Bootloader: Programming timeout	64
Bootloader: CRC command timeout.....	64
Bootloader: CRC error	64
Invalid response from bootloader	64
<i>Supported Configuration and Status Sentences</i>	65
Introduction.....	65
Configuration commands and status reports	65
Example.....	65
Standard NMEA 0183 Sentences.....	66
\$MXPGN – NMEA 2000 PGN Data.....	66
NMEA 2000 Reception	66
NMEA 2000 Transmission.....	66
Examples.....	67
\$--XDR – Sensor Data	67
TAG Blocks	67
Proprietary NMEA 0183 Sentences - General.....	68
\$PSMDCF – Set Configuration.....	68
\$PSMDCFQ – Get Configuration.....	68
\$PSMDCNV – Set Conversions.....	68
\$PSMDDR – Set Default Route.....	70
\$PSMDID – Set Talker ID	70
\$PSMDIN – Input modes.....	71
\$PSMDLDR – Loader message.....	72
\$PSMDMB – Modbus	73
\$PSMDMB,C,X – Define Modbus Slave/Register	73
Modbus,C,DELETE – Delete Table.....	73
\$PSMDMB	74
\$PSMDMB,C,R.....	74
\$PSMDMB,D	74
\$PSMDMB,E.....	75
\$PSMDOP – Set Options	75
\$PSMDOV – Overflow.....	76
\$PSMDPR – Priority	77
\$PSMDRESET – Reset the multiplexer.....	77
\$PSMDRTE – Set Route.....	77
\$PSMDSP – Set Speed.....	78
\$PSMDST – SeaTalk Data.....	79
\$PSMDUI – Set Unique Identifier	79
\$PSMDVER – Get Version	79
\$PSMDXDR – Specify Transducer ID	80
Proprietary NMEA 0183 Sentences – NMEA 2000.....	81
\$PSMDNA – Set NMEA 2000 Source Address.....	81
\$PSMDNC – ISO Address Claim Message/ISO Command Address	81
\$PSMDND – Set NMEA 2000 Device Instance	81
\$PSMDNF – Set NMEA 2000 Class and Function Code	82
\$PSMDNI – Command Device and System Instance	83
\$PSMDNM – Set Manufacturer Code	83
\$PSMDNO – Set NMEA 2000 Options.....	83
\$PSMDNP – NMEA 2000 Product Information	84
\$PSMDNR – NMEA 2000 PGN Request.....	84

\$PSMDNS – Set NMEA 2000 System Instance.....	85
<i>Technical Specifications</i>	86
<i>Contact Information</i>	86

Introduction

The MiniPlex-3PRO NMEA 0183/2000 multiplexer/gateway enables connection of multiple NMEA 0183 devices to an NMEA 2000 and an Ethernet network. Conversion is provided between NMEA 0183 and NMEA 2000 in both directions and a routing table gives full control over which data is routed where. The Ethernet port is used to transmit NMEA 0183 data onto an Ethernet network and also to receive NMEA 0183 from the same network, to be routed to one or more NMEA 0183 ports and to the NMEA 2000 network.

NMEA 0183 Ports

The NMEA 0183 ports are the inputs/listener ports and outputs/talker ports of the MiniPlex-3PRO, which connect to NMEA 0183 ports on navigation instruments, chart plotters etc. There are many interpretations and variations of NMEA 0183 ports, so we'll explain a few things first.

NMEA 0183 Signals

Although the NMEA 0183 standard specifies the signal names, voltage levels and connection methods very clearly, the reality is far from this ideal world.

The most important property of an NMEA 0183 port is that the connections or wires are labelled "A" and "B" and that it uses differential signalling according to the RS422 standard. This means that data is transmitted on both wires, using opposite voltages. Both wires are driven between 5V and 0V and opposite of each other: when wire A is at 5V, wire B is at 0V and vice versa. The advantage of this type of signalling is its resilience against electrical interference.

NMEA A and B are often labelled as *NMEA +* and *NMEA -* respectively. Other commonly used names for outputs are *TX+/TX-*, *Out+/Out-* or *Out ve+/ve-*. Inputs are often labelled as *RX+/RX-*, *In+/In-* or *In ve+/ve-*.

In all these cases, a "+" terminal connects to an A terminal of the MiniPlex-3PRO and a "-" terminal connects to a B terminal of the MiniPlex-3PRO.

Some devices even have NMEA + and NMEA - labelled the wrong way. It is perfectly safe to swap the wires in case no signal is received.

Things get confusing when manufacturers don't follow the NMEA 0183 standard, which is very often the case. Many devices have an NMEA 0183 interface, which is electrically speaking an RS232 interface. The only resemblance with the NMEA 0183 standard is the data format. Electrically, they operate on different voltages and the signal names are different. The signal names used differ wildly and often lead to confusion. When a device has a NMEA input with connections *Data In* and *Data Return*, it is often not clear whether this input is galvanically isolated or if *Data Return* is simply another name for *Signal ground* or even a *power ground*.

Instead of being fully compatible with the NMEA 0183 standard, many devices use single-ended inputs and outputs, where data is transmitted or received through one single wire while the power ground provides the return path. Single-ended devices often use connection names like *TX* and *Gnd* (transmit and ground) for an NMEA 0183 output while *RX* and *Gnd* (receive and ground) are being used for an NMEA input. Also used are *Data Out*, *Data In* and *Signal Ground*. Mix these with standard NMEA connections and confusion is imminent!

The MiniPlex-3PRO eliminates the confusion through its galvanically isolated NMEA inputs and outputs. Because of this isolation, a ground reference no longer exists. Both the A and B signals of every NMEA 0183 port of a MiniPlex-3PRO are completely "floating" and can be connected to any type of NMEA 0183 input or output of a device, whether they are differential or single-ended, RS422 or RS232.

NMEA 0183 Inputs

The MiniPlex-3PRO has eight NMEA 0183 inputs, called *In1* to *In8*. Each input should be connected to one output only. These inputs are galvanically isolated from the MiniPlex-3PRO, as specified by the NMEA 0183 standard. Because of this isolation, it is safe to connect an input to any kind of output: NMEA/RS422 or RS232. In case of an RS232 output, its *Ground* connection must be connected to the B terminal of the NMEA input.

The default communication speed of the NMEA 0183 inputs is 4800 Baud. Higher speeds up to 115200 Baud can be selected.

***The speed setting of NMEA In3 is linked to the speed setting of NMEA Out3!
When you change the speed of In3, the speed of Out3 will follow.***

NMEA 0183 Outputs

The MiniPlex-3PRO has four NMEA 0183 outputs called *Out1* to *Out4*. Each output can drive up to four NMEA 0183 inputs. These outputs are galvanically isolated from the MiniPlex-3PRO. Because of this isolation, it is safe to connect an output to any kind of input: NMEA/RS422 or RS232. In case of an RS232 input, its *Ground* connection must be connected to the B terminal of the NMEA output.

The default communication speed of the NMEA 0183 outputs is 4800 Baud. Higher speeds up to 115200 Baud can be selected.

***The speed setting of NMEA Out3 is linked to the speed setting of NMEA In3.
When you change the speed of Out3, the speed of In3 will follow.***

The "C" terminal of NMEA Out2 is not used for NMEA 0183 and should always be left unconnected.

Connecting to other devices

Figure 1 shows how instruments with different types of NMEA 0183 ports (NMEA/RS422 and RS232) can be connected to the NMEA 0183 inputs and outputs of the MiniPlex-3PRO. Note that it is perfectly safe to connect an NMEA 0183 output of the MiniPlex-3PRO to more than one receiving device, even if their inputs are of a different type.

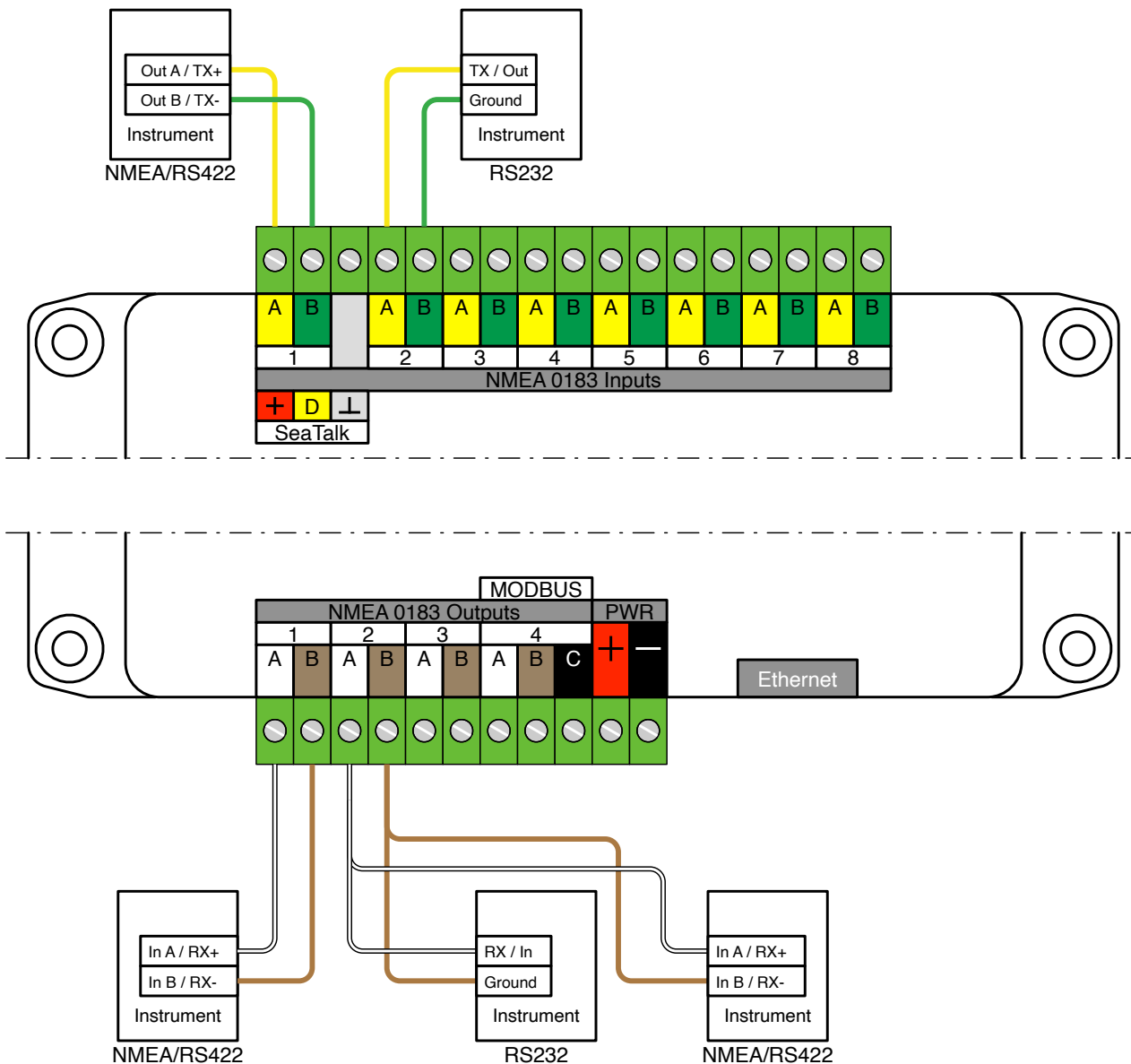

Figure 1

Combining Ports

It is sometimes necessary to combine an NMEA 0183 input and an output of the MiniPlex-3PRO to connect to another device such as a GPS with an RS232 port.

An RS232 port is a single-ended port and provides three connections: *TxD* (data out), *RxD* (data in) and *Ground*. Figure 2 shows how such a GPS should be connected. The Ground connection may also be the power ground of the GPS.

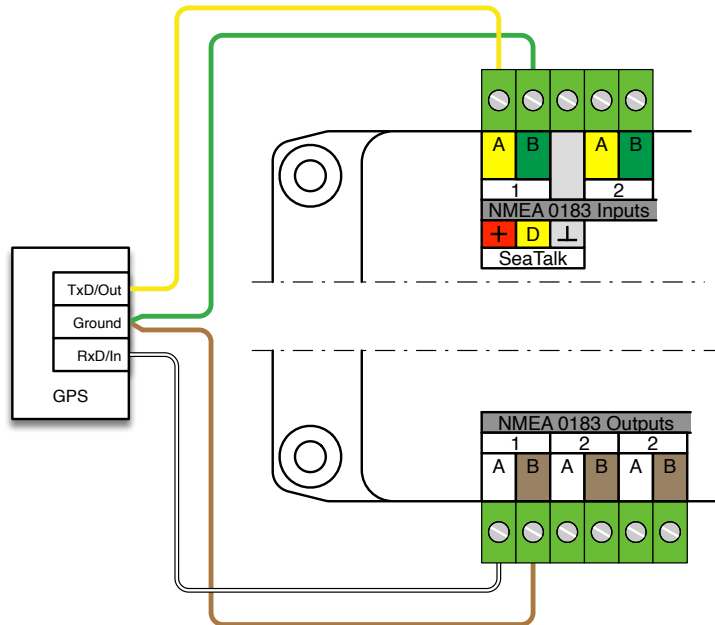

Figure 2

NMEA 2000 Port

The MiniPlex-3PRO has an NMEA 2000 port utilizing 4 screw terminals instead of an M12 DeviceNet connector. The colours correspond with the wire colours in a standard NMEA 2000 cable. A *Drop cable* with a male M12 DeviceNet connector at the other end can be connected to these screw terminals. When using a ready-made drop cable, cut off the *female* connector and connect the individual wires to the terminals on the MiniPlex-3PRO. The screen of the cable must be left unconnected, do not connect it to the black/- terminal!



Figure 3

An NMEA 2000 network has a strict topology: it consists of a backbone cable with *terminators* at each end and a *power-T* to provide power to the network. Each device is connected to this backbone using a *T*, a three-way connector block which is inserted into the backbone and a *drop-cable* or *spur-cable*.

The backbone is galvanically isolated from the rest of the electronics on your boat. A power-hungry device such as a plotter or an autopilot with its own power supply connections has a galvanically isolated NMEA 2000 interface. A smaller display or sensor may be powered from the backbone though if no other electrical connections exist on that display or sensor.

Each end of the backbone has a terminator, which is a resistor between both data wires CAN_H and CAN_L, absorbing electrical reflections on the network. Without these terminators, digital signals will reflect against the open ends of the network back into the network, causing distortion of the digital signals.

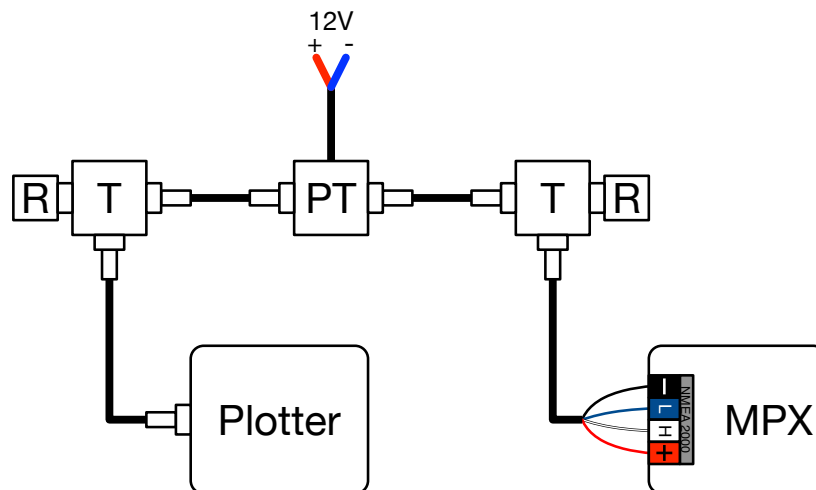

Figure 4: Minimalist NMEA 2000 Network

Figure 4 shows a minimal NMEA 2000 network with a plotter and a MiniPlex connected to an NMEA 2000 backbone.

Besides cables, this setup requires the following components:

- PT: Power Tee, supplies power to the NMEA 2000 network
- T: Tee for a drop cable to a device
- R: Terminator resistor (2x!)

Simply connecting the MiniPlex directly to the plotter using a single NMEA 2000 cable will not work. The NMEA 2000 interfaces of both devices require power from the backbone and termination to prevent data corruption.

Ethernet Port

The MiniPlex-3PRO has an Ethernet port to connect it to a network or router. Through this port, other devices on the network can receive NMEA 0183 data from the MiniPlex-3PRO and they can send NMEA 0183 data to the MiniPlex-3PRO. This Ethernet port is also called a *host* port.

An application connects to the MiniPlex-3PRO using its IP address and port number 10110. The default protocol is UDP and can be changed to TCP in the Network Settings.

Using a MiniPlex-3PRO for the first time can be challenging, depending on how the MiniPlex-3PRO is connected to your computer or network. It also requires some basic networking knowledge, which can be found in chapter **Network Basics** on page 15.

Several scenarios are possible, all requiring a different procedure:

1. Existing network/router with DHCP
2. Existing network with static IP addresses/no DHCP
3. Direct connection to a computer

These scenarios also determine how and which IP address the MiniPlex-3PRO has.

1. Existing network/router with DHCP

This is probably the most common situation. A router on the network provides internet access and has its DHCP server enabled. All devices on that network will automatically receive a unique IP address and network mask from the router and so will a MiniPlex-3PRO in its factory settings. This places all devices within the same logical network: the masked part of their IP address, the network address, is the same for each device (see chapter **Network Basics** on page 15) and they can all communicate with each other.

Start MPXConfig3Pro, set the **Port** selector in the **MiniPlex Connection** box to UDP and use menu option **Tools > Network > Search** to find the MiniPlex-3PRO. A window will show the MiniPlex-3PRO and its IP address (Figure 5). Check if the listed IP address is not an Auto-IP address in the 169.254.x.x range. This indicates a failure to obtain an IP address from a DHCP server.

Select the entry and click **OK** or double-click on the entry in the list. On the main window of MPXConfig3Pro, the IP address is now visible in the **Host** field in the **MiniPlex Connection** box. If you click on the **Connect** button, a connection to the MiniPlex-3PRO is established and you can configure it.

Searching for the very first time will most likely trigger a Windows Security Alert. In this window, you must allow MPXConfig3Pro to communicate on all listed network interfaces. Click on **Allow Access** and start the search again.

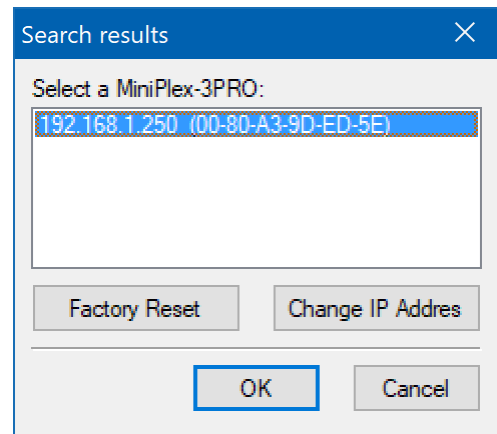

Figure 5

If no Windows Security Alert appears and no MiniPlex-3PRO is listed in the search results, you most likely have other firewall software block access for MPXConfig3Pro. Configure that firewall to allow MPXConfig3Pro to access through TCP and UDP ports 10110 and 30718.

On macOS, signed software such as MPXConfig3Pro for macOS is automatically allowed to receive incoming connections, so no special action is required to allow MPXConfig3Pro for macOS to work.

2. Existing network with static IP addresses/no DHCP

All devices on the network have a manually assigned unique IP address and network mask. Since there is no DHCP server on the network, the MiniPlex-3PRO will not receive an IP address. Instead, it will assign itself an Auto-IP address in the 169.254.x.x range. This IP address will be shown in the **Search results** window. Since this IP address is on a different logical network than the computer running MPXConfig3Pro, it is not possible to establish a connection to the MiniPlex-3PRO. Even menu **Tools > Network > Network Setup** will not work because this also requires the MiniPlex-3PRO to be on the same logical network.

The only way to get the MiniPlex-3PRO on the same network is to select the listed MiniPlex-3PRO and click on **Change IP Address**. This opens the **Assign IP Address** window (Figure 6). The **MAC Address** field already contains the MAC address of the MiniPlex-3PRO. Enter an IP address that is unique within your network and click **OK**. MPXConfig3Pro will now broadcast this IP address to the MiniPlex-3PRO, and the **Search results** window will list the MiniPlex-3PRO with the newly assigned IP address.

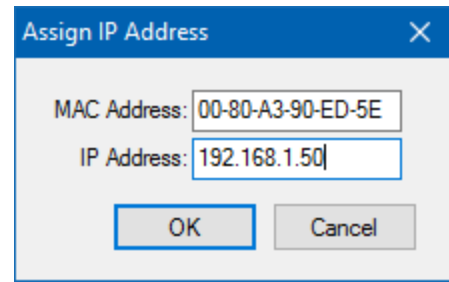

Figure 6

Select the entry and click **OK** or double-click on the entry in the list. On the main window of MPXConfig3Pro, the IP address is now visible in the **Host** field in the **MiniPlex Connection** box. If you click on the **Connect** button, a connection to the MiniPlex-3PRO is established and you can configure it.

Note that no network mask needs to be specified. A correct network mask is required but the Ethernet interface of the MiniPlex-3PRO will assign itself a correct network mask based on the entered IP address.

3. Direct connection to a computer

In this case, the MiniPlex-3PRO is connected directly to a computer using a single Ethernet cable. Ensure that the Link-LED (LNK) on the Ethernet port of the MiniPlex-3PRO lights up green or amber. If this LED is off, there is no physical connection between the transmitters and receivers in both Ethernet ports (MiniPlex-3PRO and computer). Most computers can automatically switch their transmitter and receiver pins on the Ethernet connector, but some can't. In that case, an ordinary Ethernet cable cannot be used and a so called cross-cable is required.

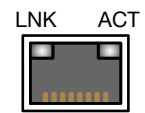

Figure 7

When the Link-LED is lit, you need to establish if the IP assignment of your computer is set to **Manual** or **Automatic (DHCP)**. You can check that in the Windows network settings.

In either case, it is required that both the MiniPlex-3PRO and the computer use the same mode of operation: either they both use Automatic and communicate using their Auto-IP addresses or they must both be set to a unique fixed IP address and network mask, so they are both in the same logical network.

If the IP assignment of your computer is set to **Automatic (DHCP)**, use MPXConfig3Pro menu option **Tools > Network > Search** to find the MiniPlex-3PRO. It will show up in the **Search results** window with an Auto-IP address in the 169.254.x.x range.

Select the entry and click **OK** or double-click on the entry in the list. On the main window of MPXConfig3Pro, the IP address is now visible in the **Host** field in the **MiniPlex Connection** box. You can now try to establish a connection to the MiniPlex-3PRO on the MPXConfig3Pro main window by clicking on the **Connect** button.

If your computer is set to **Manual**, either change it to **Automatic (DHCP)** or follow the steps in (2) to set the MiniPlex-3PRO to a fixed IP address and network mask.

Network Setup

To change any of the network settings, make sure the IP address of the MiniPlex-3PRO is in the **Host** field in the **MiniPlex Connection** box on the MPXConfig3Pro main window and select menu **Tools > Network > Network Setup**. This will open the **MiniPlex-3PRO Network Settings** window as shown in Figure 8.

These are the factory default settings. The IP address shown here is 0.0.0.0, which indicates the MiniPlex-3PRO is set to DHCP. This address is different from what is shown in the **Search results** window because the latter shows the IP address received from a DHCP server or the Auto-IP address.

If desired, a fixed IP address and a matching network mask can be entered that matches your network. The Gateway IP can be left to 0.0.0.0 if you are not going to set the MiniPlex-3PRO to UDP Directed.

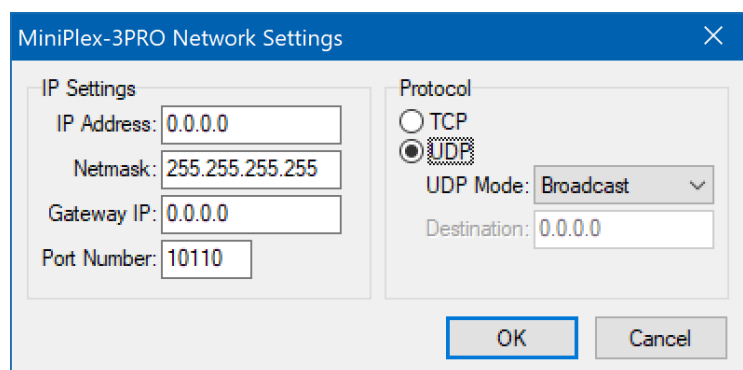

Figure 8

Figure 9 shows an example of fixed IP settings.

The protocol is set to **UDP**. This is the preferred method for NMEA 0183 data. UDP Mode **Broadcast** ensures that all devices and computers on the same network will be able to receive the NMEA 0183 data. At the same time, all devices on that network will also be able to send NMEA 0183 to the MiniPlex-3PRO.

When the MiniPlex-3PRO is connected to a WiFi router, all WiFi connected devices will also be able to receive NMEA 0183 data.

Note that UDP Broadcasts always remain within one network. If NMEA 0183 data needs to be transported across network boundaries or over the Internet, either UDP Mode **Directed** or TCP need to be used. Both modes limit the number of hosts that can communicate with the MiniPlex-3PRO to one!

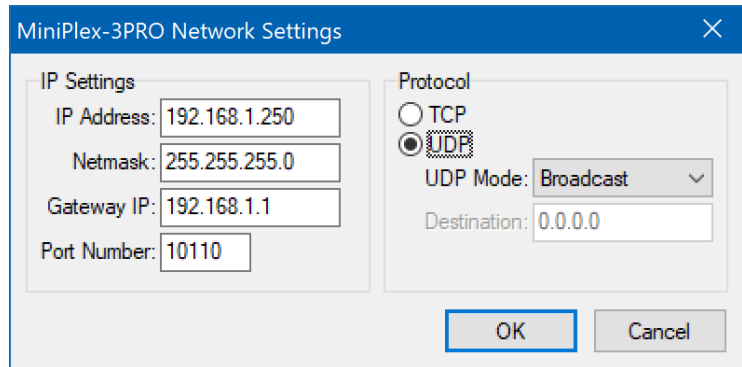

Figure 9

UDP Mode: Directed

If you set the UDP Mode to **Directed**, you must enter a destination IP address in the **Destination** field. If this IP address is not on the same network as the MiniPlex-3PRO, you must also enter the address of your network gateway in the **Gateway IP** field if the MiniPlex-3PRO is not set to DHCP.

When these settings are activated, you will no longer receive any NMEA 0183 data from the MiniPlex-3PRO as they are now transmitted to the destination IP address only. MPXConfig3Pro will no longer be able to read any NMEA related setting nor can they be changed. The network settings however can always be changed regardless of this setting.

So, when UDP mode **Directed** is to be used, first configure the NMEA settings of the MiniPlex-3PRO using UDP mode **Broadcast**. Only when all NMEA related settings are completed and verified, change the UDP mode to **Directed**.

TCP

Using the TCP protocol is another way to reach the MiniPlex-3PRO across network boundaries or over the Internet. Since the TCP server in the network interface supports only one connection, the number of computers/devices that can access the MiniPlex-3PRO via TCP is limited to one.

Port Number

The default port number for NMEA 0183 data is 10110. This is the standard port number for NMEA 0183 over UDP and TCP. MPXConfig3Pro uses this port number by default. Some apps however, work with a different and fixed port number.

Saving the Network Setup

If you click on the **OK** button to save the network settings, a progress bar will appear, and the network interface will be restarted. This takes approx. 7 seconds. The new IP address and protocol will appear automatically in the **MiniPlex Connection** box on the main window of MPXConfig3Pro when the process is completed.

It is important to know that the protocol chosen in the **MiniPlex Connection** box on the main window of MPXConfig3Pro only defines how MPXConfig3Pro connects to the MiniPlex-3PRO. It does not change the protocol of the MiniPlex-3PRO itself. So, if you need to change the protocol from UDP to TCP, you first need to change the network settings of MiniPlex-3PRO and then choose TCP in the **MiniPlex Connection** box.

Reset to DHCP

To change the network settings from fixed IP back to DHCP, open the network configuration, set the **IP Address** and **Gateway IP** fields to 0.0.0.0 and click OK.

The settings of the MiniPlex-3PRO cannot be verified after this change, so a warning will appear. You will now need the **Search** function to find the MiniPlex-3PRO with its DHCP-assigned IP address.

Network Recovery

If a MiniPlex-3PRO has a fixed IP address outside the network range or if it doesn't show up in the search results window due to a possible misconfiguration in the network settings, menu option **Tools > Network > Assign IP** can be used to recover from such a situation.

In the **Assign IP Address** window (Figure 10), enter the MAC address of the MiniPlex-3PRO which can be found on the label on the topside of the device, below the serial number.

Enter the MAC address with the fields separated by dashes as shown. Then enter a valid IP address for your network or 0.0.0.0 to reset the MiniPlex-3PRO to DHCP and click on OK. A progress bar will appear during the update process, which will take approximately 10 seconds. After that, the MiniPlex-3PRO can be found again using the Search option.

In case of a duplicate IP address on the network, it is necessary to disconnect the "offending" device first, before being able to control/reset the MiniPlex-3PRO.

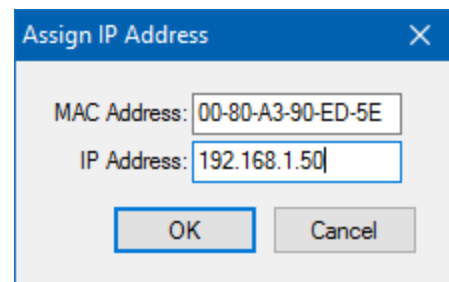

Figure 10

Network Basics

To understand how a networked MiniPlex-3PRO works and how to connect to it, some basic knowledge of IP addresses, port numbers and protocols is required.

IP Address

Every device on a network has a unique number to be able to identify that device. This allows us to send a message to one single device on a network. These numbers are called *MAC addresses*. Every device in the world that is connected to a network has such a MAC address. The MAC address of a device is sometimes printed on a label and looks like this:

00-20-4A-E4-28-58

These hexadecimal addresses are a bit cryptic and not easy to work with, and there are not enough MAC addresses available for each networking device in the world. Therefore, a mechanism is used to assign an easier to read number to a device, called an *IP address**. An IP address consists of four numbers grouped together, separated by dots. Each number can range from 0 to 255. An IP address looks like this:

192.168.1.45

Assigning an IP address to a device could be compared to sticking a coloured label to your house. Now the postman only needs to remember the colour of your label instead of your complete address. Of course, someone needs to manage a list that matches the colour to your address to prevent two houses of receiving the same-coloured label. Networks and network devices have mechanisms built in that take care of this, so we don't have to worry about it (ARP or Address Resolution Protocol).

Network Mask

Another tricky bit of networking is a *network mask*. A network mask basically determines (masks) which part of an IP address is the network address and which part is the device address. In its most basic form, a network mask consists of four numbers, like an IP address, that are either 255 or 0. And the 255's always come first. A device always has an IP address AND a network mask, for instance:

192.168.1.45 and 255.255.255.0

This combination of IP address and network mask tells us that the first three numbers (or more precisely: the first 24 bits) of the IP address are the network address (192.168.1.0) and the fourth number (45) is the device address. It also means that this combination limits the number of devices on this network to 254. 0 is the network address and 255 is the *broadcast* address, used to address all devices on the network at once.

A broadcast address allows us to send a single message to all devices on the network, instead of sending it to one single device. This is called a *broadcast* (see below). In this example, the broadcast address is 192.168.1.255. The last number here is 255, which means that it targets all devices on the network.

Having an IP/network mask combination of 192.168.1.45/255.255.0.0 means that the network address is 192.168.0.0 and the device address 1.45. There are 65534 possible devices (0.0 and 255.255 are reserved) and the broadcast address is 192.168.255.255.

If you're completely lost at this point, don't worry. Just remember the two requirements for devices to be able to communicate with each other:

1. All devices must have the same netmask
2. All devices must have the same network address

If two devices are connected to the same physical network and their network masks differ, they won't be able to communicate with each other since they are both on a different *logical* network.

Port Number

A *port number* can be seen as a sub address within one single device. It allows a single device to offer multiple services, identified by a port number.

A network message always contains the IP address of the sender and the receiver and a port number. The port number is just a logical number identifying the type of data or service in the message.

Different port numbers allow a web server to offer standard http through port number 80, https through port number 443 and e-mail services through other port numbers.

* The MiniPlex-3PRO only support IP V4 addresses.

Port numbers are not chosen arbitrarily. A certain range is standardized and controlled by an organization called IANA.

The MiniPlex-3PRO uses port number 10110, which is a registered port number for NMEA data. This is the port number you enter in your navigation software.

The MiniPlex-3PRO uses port number 30718 for configuration of the network interface. MPXConfig3Pro uses this port to transfer the contents of **Network Settings** dialog to the MiniPlex-3PRO.

Assigning IP addresses/DHCP

When devices are connected to a network, they must all have a unique IP address and a matching network mask. One way of achieving this is to set the IP address and network mask of each device manually. The other way is to let a DHCP server take care of this.

DHCP is an acronym for Dynamic Host Configuration Protocol, which it is a mechanism to automatically assign IP addresses, network masks and other parameters to devices (hosts) on a network. A DHCP server on a network will respond to requests from DHCP clients to obtain an IP address.

In a typical network environment, a router acts as a DHCP server while other devices such as computers, tablets and smartphones are DHCP clients receiving IP addresses from the DHCP server. This ensures that you can connect these devices to the network without worrying about IP addresses and network masks, all of this is taken care of by the DHCP server.

The MiniPlex-3PRO has a DHCP client and thus relies on a DHCP server already present on the network to obtain an IP address and network mask automatically. If no DHCP server is present, you must manually setup an IP address and network mask. This is the case for instance, if your "network" is just the MiniPlex-3PRO and a computer. Obviously, you will need to assign a manual IP address and network mask to your computer too in this case.

Auto-IP

When DHCP requests remain unanswered, a device assigns itself an IP address in the range of 169.254.0.0 to 169.254.255.254 with a network mask of 255.255.0.0. This is called an Auto-IP address. Although two devices with an Auto-IP address on the same network can perfectly communicate with each other, this is not a desired situation because these addresses are assigned randomly. Also, the time it takes for a device to auto-assign varies wildly from a few seconds to over a minute.

Protocols

Two transport protocols are available for sending data over the network: UDP and TCP. UDP can be used in two different modes: Broadcast and Directed.

A metaphor describing the differences between these protocols:

UDP Broadcast: A speaker (the MiniPlex-3PRO), in front of an audience (all computers on the network). The speaker talks, the audience listens. But the speaker does not know who listens and who doesn't. There is no direct "connection" between the speaker and each individual. Each person in the audience can shout something at the speaker and the entire audience will hear what he says, including the speaker.

UDP Directed: A speaker addresses one single person in the audience and all others cover their ears. The speaker will however hear everyone in the audience.

TCP: Call someone on the phone. Your navigation software or MPXConfig3Pro calls the MiniPlex-3PRO to send and receive navigation data and configuration commands respectively. But the MiniPlex-3PRO can answer only one phone call at a time.

UDP Broadcast

NMEA sentences are transmitted on the network as UDP messages to the *broadcast* address. Every device on the network will receive these messages. At the same time, any device on the network can send data to the MiniPlex-3PRO, either to its IP address (directed) or as a broadcast. UDP Broadcast has the following properties:

- Every device on the network will receive NMEA data from the MiniPlex-3PRO.
- Every device on the network can send NMEA data to the MiniPlex-3PRO.
- Other MiniPlex-3PROs on the same network will also receive each other's data. It is therefore possible to send NMEA data over the network from one NMEA device to another. Care should be taken to prevent buffer overflows by selectively routing the desired NMEA data to an NMEA output at the receiving end and blocking unwanted NMEA data.

- Routers do not pass UDP Broadcasts from one network to another, so this mode can only be used on one physical network.
- Delivery of NMEA data is not guaranteed, messages can be lost.
- Wi-Fi routers often assign a low priority to UDP broadcasts, resulting in dropped messages. Typically, up to 5% of the messages gets lost.

To be able to receive UDP on a specific port number, 10110 in our case, an application needs to setup a UDP connection and *bind* this connection to the port number. Operating systems generally allow only one application to bind to a port number. This implies that while UDP broadcasts reach every single *device* in a network, only one application on each device can receive these broadcasts. It is therefore not possible to run navigation software and MPXConfig3Pro simultaneously on the same computer.

UDP Directed

When using directed UDP, data is transmitted on the network as UDP messages to a specific IP address. Only one device with a matching IP address will receive these messages. The advantage is that directed UDP travels across routers and networks and can therefore also be used to send NMEA data over the Internet. Any device on the network can send data to the MiniPlex-3PRO either to its IP address (directed) or as a broadcast. Directed UDP has the following properties:

- Travels across routers/networks and the Internet.
- Higher chance of delivery than UDP broadcast.
- Every computer on the network can send NMEA data to the MiniPlex-3PRO.
- Only one computer can receive NMEA data from the MiniPlex-3PRO.
- Delivery of NMEA data is not guaranteed, messages can be lost.

TCP

When using TCP, an application opens an exclusive connection with the MiniPlex. The MiniPlex-3PRO is the TCP server, the application is the TCP client.

The TCP protocol is reliable and guarantees delivery of data. Data is acknowledged by the receiver and retransmitted if data is lost on its way to the receiver. A TCP connection is bi-directional, so the application that opens the connection can both receive and transmit data from/to the MiniPlex-3PRO.

The MiniPlex-3PRO is limited to *one single TCP connection* at a time.

TCP has the following properties:

- Travels across routers/networks and the Internet.
- Only one computer or similar device may communicate with the MiniPlex-3PRO.
- Reliable connection. Lost messages are automatically retransmitted.

Although TCP might seem the best option from the above, it is favourable to use UDP because NMEA 0183 and NMEA 2000 are also broadcast protocols without any form of acknowledgement of received data. Data is simply transmitted periodically, and a missing message is usually no problem because data is repeated.

Also, the TCP protocol enforces retransmissions on a bad connection. This can cause delays in data delivery and result in "outdated" data.

SeaTalk

Port NMEA In1 of the MiniPlex-3PRO can be switched from NMEA to SeaTalk* mode. Thus, NMEA In1 becomes a fully bi-directional SeaTalk port, capable of *receiving and transmitting* SeaTalk data. This SeaTalk port can be connected to an existing SeaTalk network as shown in Figure 11.

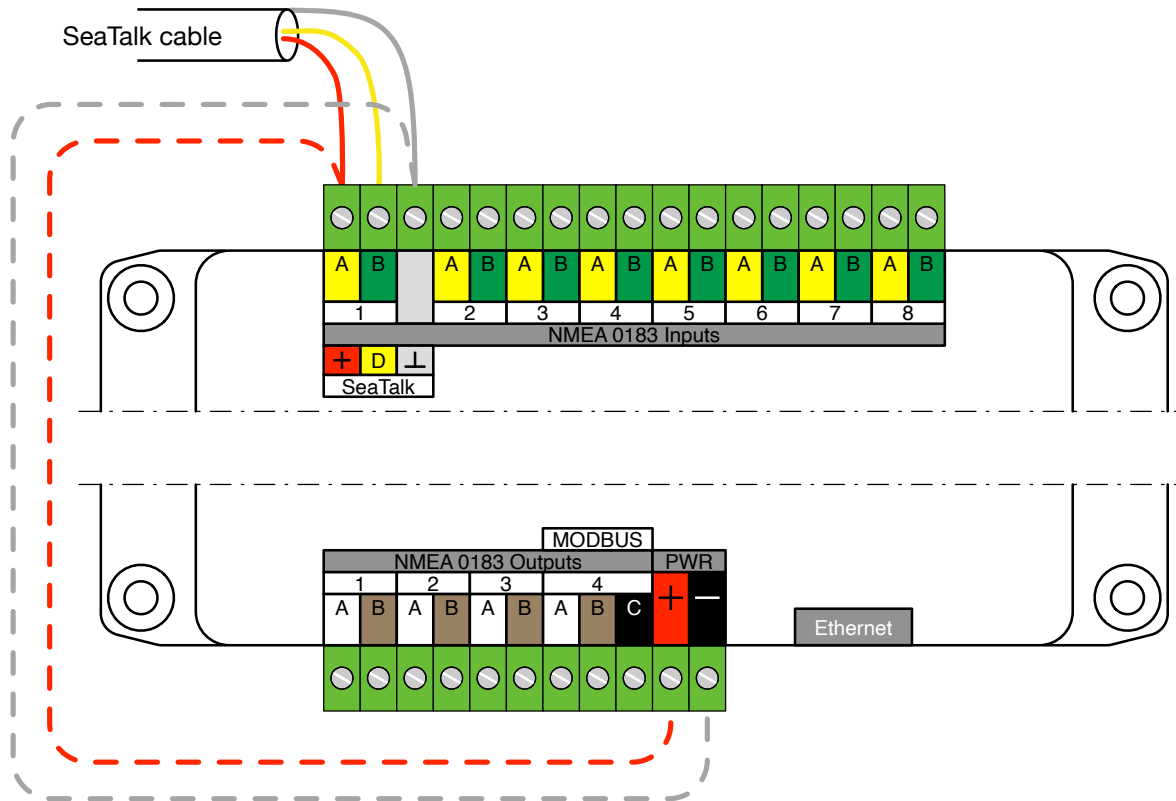

Figure 11

The SeaTalk port is galvanically isolated, so the MiniPlex-3PRO will not receive power from the SeaTalk network. If required, the MiniPlex-3PRO can be powered from the SeaTalk network by adding two wires, indicated by the dashed red and grey lines in Figure 11. It is recommended though to power the MiniPlex-3PRO separately.

The MiniPlex-3PRO can replace the Raymarine PC/SeaTalk/NMEA Interface Box (E85001). All SeaTalk datagrams required for navigation purposes, including controlling an autopilot, are supported.

Data is also converted between SeaTalk and NMEA 2000/SeaTalk^{NG} and the MiniPlex-3PRO can replace the Raymarine SeaTalk-STNG converter (E22158) if In1 is set to **SeaTalk-STNG**.

Conversions from SeaTalk to NMEA

All SeaTalk data is converted automatically to NMEA 0183 and NMEA 2000. The routing table can be used to selectively route converted data to the NMEA 0183 outputs and the host port. See the **Technical Reference** starting on page 53 for an overview of supported SeaTalk datagrams.

Conversions from NMEA 0183/2000 to SeaTalk

No NMEA 0183 or NMEA 2000 data is converted to SeaTalk by default, because there can be multiple NMEA 0183 or NMEA 2000 sources of the same data, whereas on a SeaTalk network only one single source of a particular type of data may exist.

It is therefore always required to use the routing table to define which NMEA data is converted to SeaTalk. When In1 is set to SeaTalk mode, the **ST** column in the **Outputs**-section of the routing table will be enabled and a checkbox in that column enables the conversion of the NMEA sentence of that entry to SeaTalk.

* SeaTalk is not to be confused with SeaTalk^{NG}, which is Raymarine's own version of NMEA 2000. The original SeaTalk is also referred to as SeaTalk¹.

Example

The example in Figure 12 shows the required routing entry to let a navigation application control an autopilot connected through SeaTalk. The GPRMB sentence contains all the parameters the autopilot requires.

	Inputs										NMEA 2000 Sources		Outputs							
	ST	2	3	4	5	6	7	8	C	H	N	Device	Sentence	Div	1	2	3	4	ST	PC
1										✓			GPRMB							✓

Figure 12

NMEA 2000

The MiniPlex-3PRO is an NMEA 2000 Certified device and fully compliant with NMEA 2000 V2.000. Some NMEA 2000 V1.3xx features are implemented to improve interoperability with NMEA 2000 V1.3xx compliant devices.

NMEA 2000 messages, called PGNs, are converted into NMEA 0183 sentences and vice-versa. No NMEA 2000 data is transmitted on the host port simply because there is no communication standard defined for this.

Devices and Virtual Devices

Every device on an NMEA 2000 network announces itself on start-up and when interrogated by another device. This way each device knows about other devices on the network, allowing it to select a specific device as data source.

This requires that every device announces itself by a unique number called a *NAME*.

One physical device can announce itself on the NMEA 2000 network multiple times, using a unique *NAME* for every announcement. These devices are called *virtual devices*. This way a single physical device shows up on the network as multiple virtual devices.

The MiniPlex-3PRO uses ten virtual devices: one *Main* device, and one device for each NMEA 0183/SeaTalk input and the conversion results. Thus, if a MiniPlex-3PRO is connected to a NMEA 2000 network, it will appear in the Device List of another device as shown below:

Model ID	Serial No.
MiniPlex-3PRO – Main	3C001234
MiniPlex-3PRO – In1	3C001234
MiniPlex-3PRO – In2	3C001234
MiniPlex-3PRO – In3	3C001234
MiniPlex-3PRO – In4	3C001234
MiniPlex-3PRO – In5	3C001234
MiniPlex-3PRO – In6	3C001234
MiniPlex-3PRO – In7	3C001234
MiniPlex-3PRO – In8	3C001234
MiniPlex-3PRO – Cnv	3C001234

Each of these devices transmits data that is received on the corresponding NMEA 0183 input and can be selected as a data source. This allows a specific selection of data if two inputs of the MiniPlex-3PRO receive the same type of data.

For example, if a GPS is connected to In1 and an AIS transponder to In2, there will be two sources of GPS location on the NMEA 2000 network: "MiniPlex-3PRO – In1" and "MiniPlex-3PRO – In2". On a receiving device, one of both inputs can thus be selecting as data source for GPS location.

The *Main* device transmits data received on the Host port and is the only device transmitting system-related data like System Time (PGN 126992) or the LEN value.

The virtual device ending on *Cnv* transmits NMEA 0183 conversion results.

Protocol Conversions

The MiniPlex-3PRO converts navigation data between all three supported protocols – NMEA 0183, NMEA 2000 and SeaTalk – and in all directions.

There are subtle differences however in the way each of these conversions work. Knowing these differences can be of great help when adding entries to the routing table.

The diagram below (Figure 13) shows how the data flows from one protocol to another. Since each protocol groups parameters differently, there is no one-on-one relationship between NMEA 0183 sentences, NMEA 2000 PGNs and SeaTalk datagrams. Every single parameter like a position, COG, SOG etc. is therefore decoded from the received sentences, PGNs and datagrams and stored in a database first.

From this database, the parameters are retrieved and grouped to build new sentences, PGNs and datagrams. Their route is determined, and they are transmitted again.

See the **Technical Reference** starting on page 53 for an overview of all converted NMEA 0183 sentences, NMEA 2000 PGNs and SeaTalk datagrams.

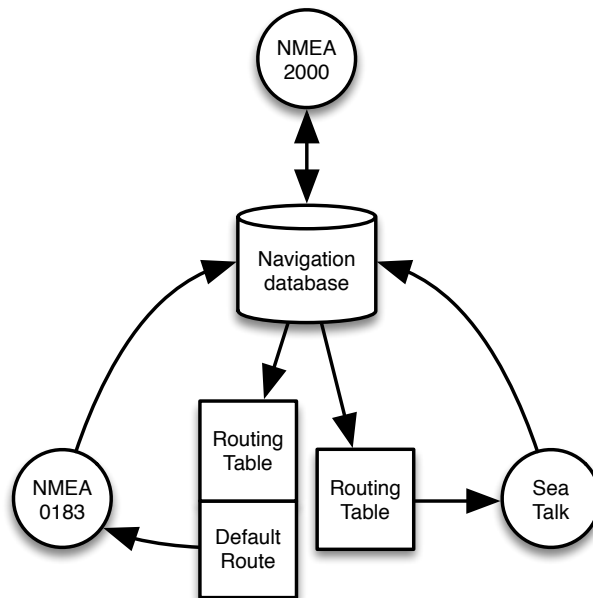

Figure 13

NMEA 0183 and SeaTalk to NMEA 2000

This conversion is very straightforward: Every received NMEA 0183 sentence or SeaTalk datagram is converted to NMEA 2000. No routing is applied since every NMEA 2000 receiving device has a means of selecting a data source.

Similar data from two or more NMEA 0183 or SeaTalk inputs on the MiniPlex-3PRO appears on the NMEA 2000 network as originating from different virtual devices.

NMEA 2000 to NMEA 0183

This conversion is controlled by the routing table or the **Default Route*** settings. NMEA 2000 data is converted into NMEA 0183 sentences, which can then be routed to any NMEA 0183 output or host interface as desired. If no match is found in the routing table or when the routing table is empty, the **Default Route** is applied. This is explained in detail in chapter **Routing** on page 40.

NMEA 2000 and NMEA 0183 to SeaTalk

These conversions are fully controlled by the routing table. None of the received NMEA 0183 or NMEA 2000 data is converted and routed to SeaTalk by default. Each sentence that must be routed/converted to SeaTalk requires an entry in the routing table.

* The Default Route is the route applied to a sentence when no match is found in the routing table. The Default Route is set by checkboxes in section **Input Settings** on the **NMEA Inputs/Outputs** tab.

SeaTalk to NMEA 0183

This conversion is controlled by the routing table or the **Default Route** settings. SeaTalk data is converted into NMEA 0183 sentences, which can then be routed to any NMEA 0183 output or host interface as desired. If no match is found in the routing table or when the routing table is empty, the **Default Route** is applied. This is explained in detail in chapter **Routing** on page 40.

NMEA 2000 and SeaTalk in the Routing Table

In NMEA 0183 sentences, the *address* field is the first field that follows the "\$" or the "!" delimiter. Since these address fields are fairly readable for human beings, they are also used to identify SeaTalk and NMEA 2000 data in the routing table of the MiniPlex-3PRO, as opposed to NMEA 2000 PGN numbers or SeaTalk datagram numbers.

This address field consists of five characters: the first two are the *Talker ID* and the last three characters are the *Sentence Formatter*. The Talker ID defines the origin of a sentence whereas the Sentence Formatter defines the type of data the sentence contains.

A \$GPRMC sentence for instance defines "GP" as its source (a generic GPS) and "RMC" as a sentence containing a full position fix, its time and date and the current course and speed over ground.

Similarly, a \$HEHDT sentence define "HE" as its source (a heading device) and "HDT" as a sentence containing a true heading. A \$GPHDT sentence defines a true heading originating from a GPS compass.

The **Technical Reference** starting on page 53 contains a list of commonly used sentence formatters and talker IDs.

Power Supply

The MiniPlex-3PRO must be powered from an externally supplied DC voltage from 8 to 35V. The power supply connection is protected against reversed polarity.

Indicators

The LEDs on the MiniPlex provide information about the status and operation of the MiniPlex-3PRO. When the MiniPlex-3PRO powers up, all LEDs flash once.

Green (NMEA 2000): This LED flashes when an NMEA 2000 PGN is received.

Green (NMEA 0183): This LED flashes upon reception of a valid NMEA sentence. During a firmware update, this LED flashes upon reception of a firmware block.

Red (Overflow): This LED flashes on a NMEA output buffer overflow, indicating that NMEA sentence will be lost due to bandwidth limitations.

During start-up, this LED is lit for a short moment while the MiniPlex-3PRO checks if firmware is loaded or if a firmware update is initiated by MPXConfig3Pro. If firmware is found, the LED goes off. When the LED stays lit, no firmware was found.

During a firmware update, this LED is on. When the update is completed, the LED goes off. If the LED stays on after a firmware update error, it indicates that no valid firmware is present.

Data Throughput

A MiniPlex-3PRO can combine several streams of data into one, but it cannot perform magic. It is obvious that if a MiniPlex-3PRO combines NMEA 0183 sentences from multiple sources, the total number of sentences that must be transmitted is the sum all sentences received from each source. So, any output port that needs to transmit these sentences must have sufficient bandwidth to do so.

The host ports is high speed and fast enough to transport all possible NMEA 0183 and NMEA 2000 data that is being received to a connected host. The NMEA 0183 outputs however are not!

The standard communication speed of NMEA 0183 is 4800 Baud or bits per second, which equals 480 characters per second.

When using a MiniPlex-3PRO to combine sentences from several sources, it is easy to create a situation in which more data is being received than can be transmitted through an NMEA 0183 output because of the speed limitations of that output. This will inevitably lead to an overflow of the output buffers inside the MiniPlex-3PRO.

Each output buffer can hold 512 bytes of data, which is slightly more than 1 second worth of data at 4800 Baud.

When a received sentence is routed to an NMEA 0183 output, it is stored in the corresponding output buffer, from where it is transmitted to the physical output port. Because of the limited size of this buffer, it is obvious that it will overflow if the buffer is filled faster than it is emptied. While it might seem a good solution to increase the buffer size to prevent overflows, it is not. It only delays the point at which this larger buffer is filled up too. It just takes a longer time.

With NMEA 0183, sentences are usually transmitted once per second (exceptions exist). It therefore makes sense to limit the size of the buffers to store one second worth of data. This also limits the delay of transmitted sentences to one second max. If more sentences need to be transmitted than a buffer can hold, they are simply no longer being added to that buffer.

Note that sentences are never dropped when being sent to a host port. The speed of a host port is 100 times higher than an NMEA 0183 port at 4800 Baud and two times higher than the speed of NMEA 2000, so it will never pose any throughput limitation. If a sentence is routed to a host port and an NMEA 0183 output, and the buffer of that output is full, that sentence will still be routed to the host port.

A buffer overflow event is signalled by the red LED on the MiniPlex and by the overflow indicators in MPXConfig3Pro.

All of the above may raise the question if it is possible at all to combine data from several inputs at 4800 Baud and still transmit this through an output at 4800 Baud.

It depends...

The standard speed of an NMEA 0183 port is 4800 Baud or bits per second, representing 480 characters per second (10 bits are needed for one character). It might seem obvious that combining four NMEA 0183 streams at 4800 baud would require the output to be operating at $4 \times 4800 = 19200$ Baud to prevent any data loss.

In general, devices do not send a continuous stream of NMEA sentences. A wind instrument for instance, typically transmits one \$WIMWV sentence per second and the length of this sentence will be 30 characters at most. Thus, the occupied bandwidth of this device is 30 char/s, leaving room (450 char/s) for sentences from other devices.

On the other hand, a GPS can transmit \$GPRMB, \$GPRMC, \$GPGLL, \$GPGGA, \$GPVTG, \$GPZDA, \$GPGSA and \$GPGSV (3x). This is a burst of 10 sentences which already exceeds the bandwidth of 480 char/s when transmitted every second. Such a GPS would typically transmit these sentences once every two seconds.

So, it totally depends on the kind of sentences received - their length and frequency - whether they can be combined and transmitted on an output operating at 4800 Baud. Simply increasing the speed of that output is often not possible because the receiving device might not have a means of increasing the speed of its input port.

There are several ways to resolve buffer overflow and loss of sentences:

1. Configure the instruments connected to the inputs of the MiniPlex-3PRO to send less sentences or at a lower rate. GPS receivers usually offer a selection of sentences to be transmitted.
2. Use the routing table of the MiniPlex-3PRO to block unwanted sentences.
3. For sentences that should not be blocked, setting a divisor in the routing table may reduce their rate or frequency. The output of a compass at rate of 10Hz can thus be throttled down to a lower rate.
4. Increase the speed of the NMEA 0183 output that suffers from overflows. This will only work when the receiving equipment also supports higher communication speeds. Connected ports must always match their communication speed (Baud rate).

In any case: a blink of the red LED means loss of data. If that occurs once every few seconds, it might not be a problem at all. But a blink every second or even faster means that one or more sentences will be lost all the time.

MPXConfig3Pro

The MiniPlex-3PRO multiplexer is configured with a tool called *MPXConfig3Pro*. This tool can be found on the accompanying CD and can also be downloaded from the Downloads page on our website. It is available for Windows and macOS.

There is no installer for this tool. It can be started directly from the CD or from the downloaded ZIP file or disk image. It is however a good practise to copy the program to a suitable folder on your hard-disk and create a shortcut on your desktop.

The MiniPlex-3PRO itself is configured with proprietary NMEA 0183 sentences. MPXConfig3Pro transmits these sentences to the MiniPlex-3PRO immediately when you change a setting.

Settings do not have to be stored explicitly except for the routing table.

All configuration settings are stored in non-volatile memory of the MiniPlex-3PRO. These settings are retained without power supply.

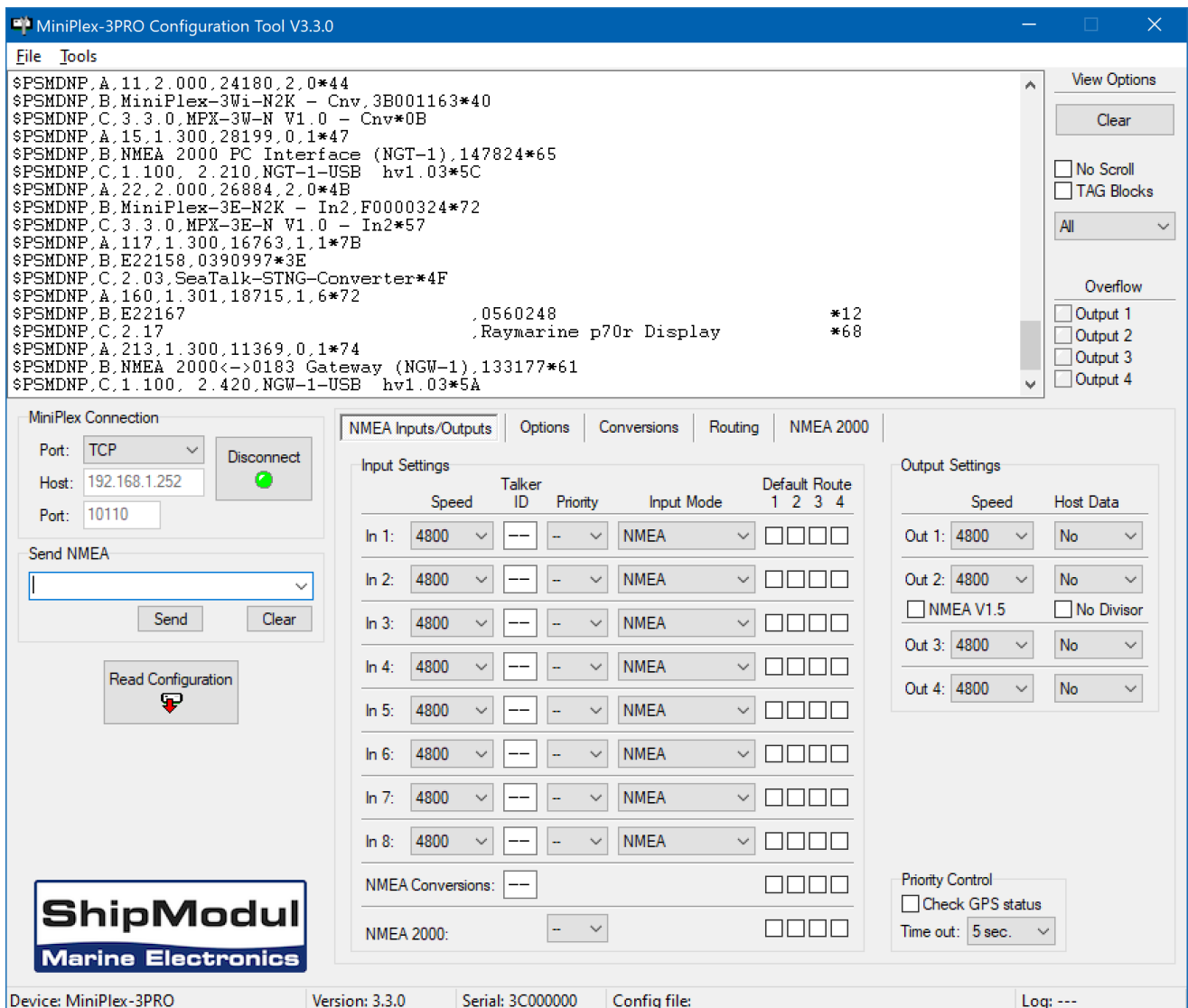

Figure 14: The MPXConfig3Pro main window

The window of MPXConfig3Pro is divided into four sections from top to bottom: the menu, the NMEA viewer and its controls to the right of it, the controls to configure MiniPlex-3PRO on the lower half of the window, and the status bar.

The NMEA viewer shows the NMEA 0183 sentences transmitted by the MiniPlex-3PRO to its host port. These sentences include NMEA sentences received on its inputs (NMEA 0183, SeaTalk and NMEA 2000) as well as status messages generated by the MiniPlex-3PRO (sentences starting with \$PSMD).

The controls on the tabbed pages determine the operation and configuration of the MiniPlex-3PRO and are grouped according to their function.

The status bar shows the name or type of the connected MiniPlex-3PRO, its firmware version number and its serial number. This information is useful when you require technical support. Also shown are the optionally loaded or saved configuration file and a line counter when a log file is being created.

Menu

The menu contains two sub-menus: **File** and **Tools**. Some options of these menus are disabled or not visible, depending on the status of the connection.

The **File** menu offers the following choices:

Log NMEA...	Start writing NMEA data to a log file. A log file is a plain text file and can read by any text editor to examine the data. The Log counter on the status bar will show the number of NMEA sentences that are currently written to the log file.
Log Diagnostic Info...	Start writing to a log file with the addition of a time stamp at the beginning of each NMEA sentence.
Stop Log	Stop writing NMEA data to the current log file and close that file.
Load Configuration...	Load a previously saved configuration file into the MiniPlex-3PRO. The current configuration will be overwritten. A configuration file stores all settings made with MPXConfig3Pro.
Save Configuration	Save the current configuration to a previously file.
Save Configuration As...	Save the current configuration to a new file.
Update MiniPlex Firmware...	Load new a firmware file into the MiniPlex-3PRO.
Exit	This exits MPXConfig3Pro.

The **Tools** menu offers the following choices:

Show Statistics	Opens a window showing bars that indicate how much data is stored in the database, the NMEA 2000 queues and the processing time for conversions.
Network	Opens a sub-menu for the MiniPlex-3PRO's network interface (only present when TCP or UDP is selected with the Port selector).
Restore Factory Settings...	Restore the MiniPlex-3PRO to its default factory configuration.
Automatic Update	Update the firmware in the MiniPlex with the firmware embedded in MPXConfig3Pro. This is the minimum required firmware version compatible with this version of MPXConfig3Pro.
About	Show a window with version information. If you double-click on the multiplexer icon in this window, MPXConfig3Pro will erase all settings stored in the Windows registry and exit. Only settings like port number and IP address are stored in the registry. No multiplexer settings are stored there.

The **Network** sub-menu is only present when TCP or UDP is selected with the Port selector and offers the following choices:

Network Setup...	Open a window to setup the network parameters of a MiniPlex-3PRO.
Search...	Search the network for MiniPlex-3PROs. A window is shown with search results.
Assign IP...	Assign an IP address to a MiniPlex-3PRO using its MAC address.

MiniPlex Connection

When connecting to a MiniPlex-3PRO for the first time, set the **Port** selector to **UDP** and follow the instructions in chapter **Ethernet** on page 11 to setup the network parameters of the MiniPlex-3PRO.

When this setup is completed, select **TCP** or **UDP** to match the protocol as set in **Network Settings**.

Enter the IP address of the MiniPlex-3PRO in the **Host** field or use menu **Tools > Network > Search** to find the MiniPlex-3PRO on your network.

The **Port** field already contains port number 10110, which is the standard NMEA 0183 port value. When left blank, port 10110 is automatically assumed.

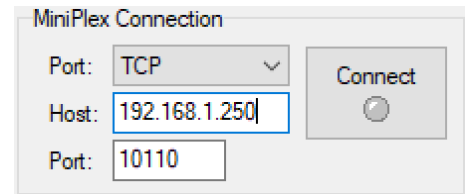

Figure 15

Click on the Connect button to initiate the connection. MPXConfig3Pro will immediately read the current configuration from the MiniPlex-3PRO.

UDP All

Besides **TCP** and **UDP**, the **Port** selector also contains **UDP All**. This connection method will show NMEA 0183 data from all devices that is broadcast on the network. No configuration will be read, and all configuration controls will be shown inactive.

The **Host** field must contain a valid IP address of a MiniPlex-3PRO. When a connection is established, MPXConfig3Pro will request the \$PSMDVER sentence from that MiniPlex-3PRO. If the **Host** field contains the network broadcast address (e.g. 192.168.1.255), the \$PSMDVER sentences of all MiniPlex-3PRO devices on the network are returned.

Using the **Send NMEA** field, a command can be sent to one or all MiniPlex-3PRO devices, depending on whether the **Host** field contains a host IP address or a broadcast IP address.

Reading the configuration

When the **Connect** button is clicked, MPXConfig3Pro opens a connection to the MiniPlex-3PRO and automatically retrieves its current configuration. The tabbed configuration pages will be enabled upon success and the LED on the **Connect** button will become green. Depending on the configuration of the connected MiniPlex-3PRO, the Modbus tab may or may not be visible.

Error messages may appear when attempting to connect. These messages may be helpful in determining the problem:

Multiplexer does not respond

You have entered the wrong IP address in case of a UDP connection.

Connect timed out

You have entered the wrong IP address when trying to open a TCP connection.

Socket Error # 10061, Connection refused

The IP address is correct but the MiniPlex-3PRO refused the TCP connection. This happens when another application has already opened a TCP connection or when the MiniPlex-3PRO was configured for UDP.

Could not bind socket. Address and port are already in use

Another application has already used port 10110 for UDP. Using UDP requires an application to *bind* to a port number to receive all UDP traffic on that port number. A port number can only be bound to one application at a time.

If you exit MPXConfig3Pro, the connection settings will be saved and reloaded when MPXConfig3Pro is started again. When you select a different port while being connected, MPXConfig3Pro closes the current connection.

You can also force MPXConfig3Pro to retrieve the configuration from the MiniPlex-3PRO with the **Read Configuration** button (Figure 16).

Send NMEA

MPXConfig3Pro allows manual entry of arbitrary NMEA sentences for testing, configuration etc.

Type the desired NMEA sentence in the edit box and click on the **Send** button or press the **Enter** key on your keyboard to transmit the sentence to the MiniPlex-3PRO. MPXConfig3Pro will keep a history of entered sentences/commands. These can be selected by clicking on the small arrow on the right side of the input field. A selected sentence can be transmitted again by clicking on the **Send** button or pressing the **Enter** key. It can also be edited prior to transmitting. The **Clear** button clears the history.

Preceding the NMEA sentence with a "\$" is optional, MPXConfig3Pro will add it for you if omitted. The input is case sensitive, so whatever you type will be transmitted to the MiniPlex-3PRO verbatim. Since all standard NMEA sentences are uppercase, you must enter them as uppercase.

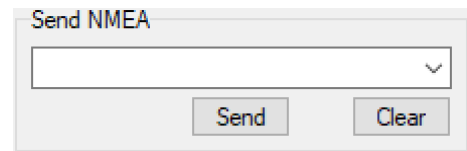

Figure 16

Any sentence starting with \$PSMD will be recognized by the MiniPlex-3PRO as a configuration command and will be processed as such. Any other sentence will be routed to any NMEA output which has its Host Data set to Yes or Override. Routes specified in the routing table will be applied too. This allows specific configuration sentences to be transmitted to connected devices.

This feature can also be used to test if an NMEA input or output is functional: Connect an NMEA output to an input, set Host Data for that output to Yes and type an arbitrary text of at least 6 characters in the **Send NMEA** field. This text should appear in the NMEA viewer when you click on the Send button or press the enter key.

View Options

The NMEA Viewer area (Figure 17) offers a few controls that make observing NMEA data easier.

The NMEA viewer itself stores up to 100 sentences which can be scrolled back (disconnect first). These sentences can also be copied and pasted into another application (Windows only).

Clear

This button clears the NMEA Viewer window.

No Scroll

When this option is enabled, a list of received NMEA sentences will be displayed, which will refresh continuously when new sentences are received. This feature allows you to closely examine the types of sentences received from the connected instruments. Any proprietary NMEA sentences that are generated by the MiniPlex-3PRO are also listed. These sentences start with \$PSMD.

Tag Blocks

This option shows any *TAG blocks* that precede a sentence. TAG blocks are enabled when MPXConfig3Pro is connected to the MiniPlex-3PRO. MPXConfig3Pro uses these TAG blocks to identify the source of a sentence (NMEA 0183 input or NMEA 2000 Source Address).

When a device connected to the inputs of the MiniPlex-3PRO transmits TAG blocks, they will also be visible.

Input selector

The input selector allows you to selectively see sentences from one specific NMEA input of the MiniPlex-3PRO, the NMEA 2000 network, conversion results or responses from the multiplexer itself.

Overflow

The overflow indicators show which output buffer suffers from an overflow. See the chapter **Data Throughput** on page 23 for ways to prevent overflow situations with different instruments.

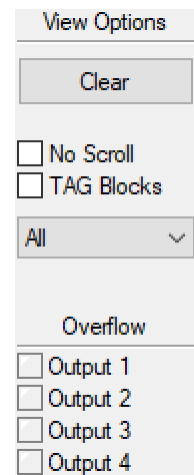

Figure 17

NMEA Inputs/Outputs

This tab contains all settings dealing with inputs and outputs of the MiniPlex-3PRO and the default routing settings. Each setting is described in detail below.

Figure 18

Input Settings

Speed

This sets the speed of each NMEA 0183 input. The default speed is 4800 Baud, which is the standard speed for navigation devices. The highest supported speed is 115200 Baud.

Some fluxgate or gyrocompasses operate at 9600 Baud or faster to accommodate the higher throughput of 20 headings per second or more. AIS receivers and transponders operate at 38400 Baud.

If you change the speed of In3, the speed of Out3 will be changed too. In3 and Out3 share the same communication port inside the MiniPlex-3PRO and therefore always have the same speed.

If the **Input Mode** of In1 is set to **SeaTalk**, the speed setting for In1 is disabled and fixed to 4800 Baud, which is the standard speed on the SeaTalk network.

Care should be taken when inputs are set to higher speeds than the outputs which they are routed to. This can possibly lead to buffer overflows. See the chapter **Data Throughput** on page 23 for more information.

Talker ID

The MiniPlex-3PRO can change the *Talker ID* of received sentences. The first two characters of an NMEA sentence are the Talker ID of that sentence, indicating the source of the data being transmitted.

For instance, in an \$HEHDT sentence, the "HE" identifies the source of this true heading sentence as a gyro compass. In a \$GPHDT sentence, the "GP" identifies the source as a GPS based compass.

Similarly, a device with both a GPS receiver and a Galileo receiver has a Talker ID "GP" when the position is GPS based, "GA" when the position is Galileo based, and "GN" for a combined navigation position from both Galileo and GPS.

Changing the Talker ID of a sentence can be required for instance when using a GPS compass. Such a compass generally transmits the true heading as a \$GPHDT sentence. A receiving device or application might however require a true heading with Talker ID "HE". By entering "HE" in the **Talker ID** field of the input connected to the GPS compass, the received \$GPHDT sentence will be changed into \$HEHDT.

Setting a Talker ID can also be useful when similar devices are connected to the multiplexer while the navigation software must be able to distinguish between the data from these devices. A catamaran for instance could have a depth sounder in each hull, both transmitting \$SDDPT sentences to the navigation software. Setting the Talker ID for those inputs to "H1" and "H2" respectively would change these sentences into \$H1DPT and \$H2DPT, allowing the receiving software to recognise both depth readings separately.

Enter the Talker ID in the edit box of the desired input and press the Enter key to send the setting to the multiplexer. A Talker ID should have upper case characters and numbers only. See the **Technical Reference** section for an overview of the most commonly used Talker IDs.

When the Talker ID is changed, the background of the edit field turns yellow to indicate that the modified Talker ID has not yet been sent to the multiplexer. Pressing Enter will send all Talker IDs to the multiplexer and the background colour will return to white. It is possible to change all Talker IDs first and press Enter after changing the last one. Starting at the Talker ID field of input 1, pressing the Tab key will jump to the Talker ID of the next input.

Clicking the **Read Configuration** button will read the Talker ID settings from the multiplexer. Any modified Talker IDs that have not been sent to the multiplexer (yellow background) will revert to their original values. To clear a Talker ID, simply clear the edit box by selecting the contents with the cursor and press the Del or Backspace key on your keyboard and finally press Enter. An empty Talker ID setting will show two dashes.

The MiniPlex-3PRO will only change Talker IDs of approved NMEA 0183 sentences. Proprietary sentences starting with "\$P" or "!P" will remain untouched, because these sentences have no Talker ID field.

There is no Talker ID setting for NMEA 2000 sources. It would be quite useless to set a Talker ID for an entire set of navigation data.

Priority

Each NMEA 0183 input of the MiniPlex-3PRO can be assigned a priority from 1 to 9. The higher values 10, 20, 50, 100 and 200 can be used for prioritizing against higher and fixed Device Instance numbers of devices on an NMEA 2000 network.

1 sets the highest priority and 200 sets the lowest. By default, no priority is set ("--"). There is no priority setting for the conversion results as these will have the same priority as the input receiving the source of the conversion.

An overall priority can be assigned to NMEA 2000 sources. Setting the priority of the NMEA 2000 port to 1 to 9 will assign this priority to all sources on the NMEA 2000 network. By selecting "DI" however, individual sources on the NMEA 2000 network can be assigned a priority by setting their Device Instance* to a non-zero value. When set to 1 or higher, the Device Instance value is compared against the priority values of the NMEA 0183 inputs, and the same check is applied: a lower value has a higher priority. To be able to prioritize from NMEA 2000 sources that don't allow their Device Instance to be changed, the NMEA 0183 inputs can be set to higher values in the range of 10 to 200.

Assigning a priority to at least two inputs or NMEA 2000 sources will cause the MiniPlex-3PRO to block duplicate NMEA 0183 sentences received/generated from the lowest priority source. If a duplicate sentence from the higher priority source is no longer received, the same sentence from the next lower priority source will be passed after an adjustable time out in the Priority Control panel.

Only the Sentence Formatter (e.g. the "RMC" part) is used for comparison - the Talker ID (the "GP" part) is ignored.

Example 1: two GPS receivers are connected to In1 and In2 with priority settings of 1 and 2 respectively. Both GPS receivers transmit \$GPRMC sentences but only those from the GPS on In1 are passed. This feature can be useful to set up a second GPS as a backup for the main GPS.

Example 2: a GPS and an AIS are connected to In1 and In2 respectively. By assigning a lower priority to In2, the duplicate GPS sentences from the AIS will be blocked.

Note that the priority system does not block an entire input; it only blocks duplicate sentences. Sentences received from the AIS like !AIVDM, which are not received from the GPS, are passed.

* The Device Instance of a device can be changed using the NMEA 2000 Device List. On tab **NMEA 2000**, click on button **Device List**, double-click on the desired device from the list and change the Device Instance in the **Device Information** window that appeared.

Table 1 shows sentences from the GPS on In1 and from the AIS transponder on In2. The higher priority of the GPS input blocks the greyed GPRMC sentence received from the AIS transponder.

GPS (In1)	AIS (In2)
GPRMC	GPRMC
GPGGA	AIVDM

Table 1

The priority system can store up to 50 different sentence types to determine their priority. An adjustable time out ensures that sentences received from lower priority sources are passed again when their duplicates from higher priority sources are no longer received or have an invalid Status Flag.

Example 3: On the NMEA 2000 network are two sources of GPS data, a mast mounted GPS antenna and a chart plotter. If the mast mounted GPS must be the primary source of GPS data and the chart plotter the secondary source, set the Device Instance of the mast mounted GPS to 1 and the Device Instance of the chart plotter to 2. If the mast mounted GPS transmits GPS data on the NMEA 2000 network, the MiniPlex-3PRO will use this GPS as the source to convert the NMEA 2000 data to NMEA 0183 sentences. When the mast mounted GPS fails or loses fix, the MiniPlex-3PRO will fall back to using the chart plotter as conversion source.

Priorities of NMEA 0183 inputs and NMEA 2000 devices the network can be mixed: the priority value of each NMEA 0183 input is compared directly to the Device Instance of NMEA 2000 data sources.

The Device Instance of an NMEA 2000 device can be changed in the **Device List** of MPXConfig3Pro or on any chart plotter that is connected to the NMEA 2000 network.

Input Mode

The NMEA 0183 inputs of the MiniPlex-3PRO can be set to different modes besides standard NMEA, to be able to receive "not quite standard" NMEA, plain text or SeaTalk. The following modes are available:

NMEA: Normal NMEA processing. This is the default processing mode in which sentences are checked for correct formatting according to the NMEA 0183 standard. Any sentence that is incorrectly formatted or has a checksum error is rejected. This behaviour meets the IEC/EN60945 requirements.

NMEA (ERR): Forward NMEA sentences with a checksum error unmodified, bypassing all further NMEA processing, routing and conversions. Only the default route is applied. This allows other devices or software to detect the checksum error.

NMEA (CR/LF): Relaxed NMEA format checking. This mode will accept incorrectly terminated sentences. Using this mode, a sentence is considered terminated if it ends on a *CR*, a *LF* or a combination of both in arbitrary order.

Text to NMEA: Receive plain text strings and forward them as \$MXTXT sentences. Any character with an ASCII value greater than 32 (a space) is regarded as the start of a string. The string must end on a *CR* or *LF* and its length may not exceed 61 characters. A longer string will result in a new \$MXTXT sentence containing the remainder of the string. Only valid NMEA characters are read. Invalid characters are stripped from the received string.
The Total number and Sentence number fields of the \$MXTXT sentence are always set to "01". The Text Identifier field of the \$MXTXT sentence contains the input number on which the string was received. When for instance "Hello World" is received on input 3, the resulting sentence will be: \$MXTXT,01,01,03,Hello World*6E.

Text to PTXT: Receive plain text strings and forward them in \$PTXT sentences. Any character with an ASCII value greater than 32 (a space) is regarded as the start of a string. The string must end on a *CR* or *LF* and its length may not exceed 71 characters. A longer string will result in a new \$PTXT sentence containing the remainder of the string. The MiniPlex-3PRO will always terminate a forwarded string with a *CR/LF* pair. All characters with an ASCII value from 32 to 127 are forwarded.

Plain Text: Receive plain text strings and forward them unmodified. Any character with an ASCII value greater than 32 (a space) is regarded as the start of a string. The string must end on a *CR* or *LF* and its length may not exceed 77 characters. A longer string will result in a new string containing the remainder of the original string. The MiniPlex-3PRO will always terminate a forwarded string with a *CR/LF* pair. All characters between from ASCII 32 to 127 are forwarded.

SeaTalk: Available on In1 only. This mode switches In1 to SeaTalk mode and fixes its speed to 4800 Baud. When this mode is selected, In1 becomes a fully bi-directional SeaTalk port which can receive and transmit SeaTalk data. See the **Technical Reference** section for an overview of the converted SeaTalk datagrams.

SeaTalk-STNG: Available on In1 of NMEA 2000 models only. This mode switches In1 to SeaTalk mode with RayMarine SeaTalk-STNG converter emulation and fixes its speed to 4800 Baud. When this mode is selected, In1 becomes a fully bi-directional SeaTalk port which can receive and transmit SeaTalk data. Conversions of SeaTalk control datagrams is also supported, like Raymarines own SeaTalk-STNG converter. This allows for instance a SeaTalk remote control to be used to control a SeaTalk^{NG} autopilot. This mode should not be used when a RayMarine SeaTalk-STNG converter is already present on the SeaTalk^{NG}/NMEA 2000 network, because this would result in a data-loop, flooding the SeaTalk bus with control messages. See the **Technical Reference** section for an overview of the converted SeaTalk datagrams.

Input "NMEA Conversions"

The results of NMEA 0183 conversions (see the **Conversions** tab, Figure 22) are available through this "virtual" input if the conversion result has the same Sentence Formatter as the originating sentence. These sentences can be routed using the default route settings and the routing table, using input column **C**. Conversion results with a different Sentence Formatter originate from the same input as the original sentence.

Input "NMEA 2000"

NMEA 2000 PGNs are converted into NMEA 0183 sentences, which are processed in the same way as NMEA 0183 sentences received on In1 to In8. They can be routed using the default route settings and the routing table, using input columns **N** and **Device**.

Default Route

These options enable a default route from the NMEA 0183 inputs, the NMEA 2000 port and the conversion results to the NMEA 0183 outputs.

The default route is applied to a sentence when no specific route for this sentence exists in the routing table. A match in the routing table always takes precedence over the default route.

There is always a default route from the NMEA 0183 inputs and NMEA 2000 port to the host port.

Output Settings

Speed

This sets the speed of each NMEA 0183 output. The default speed is 4800 Baud, which is the standard speed for navigation devices. The highest supported speed is 115200 Baud.

If an output is connected to a plotter, it is wise to set this output and the input of the plotter to a higher speed to prevent output buffer overflows. Especially when many sentences/inputs or an AIS source are routed to that output, it is essential to choose at least 38400 Baud. Most plotters support a speed of 38400 Baud or higher.

If you change the speed of Out3, the speed of In3 will be changed too. In3 and Out3 share the same communication port inside the MiniPlex-3PRO and therefore always have the same speed.

Host Data

These settings control if and how sentences from the host interfaces USB, Ethernet or WiFi are routed to each NMEA output:

No: No sentences from the host interface are routed to the NMEA output.

Yes: Sentences from the host interface are routed to the NMEA output and mixed with sentences from the inputs, SeaTalk and NMEA 2000.

Override: Sentences from the host interface are routed exclusively to the output and take precedence over any sentence from the inputs, SeaTalk and NMEA 2000. When the host sends sentences to the MiniPlex-3PRO, no other sentences are routed to that output. When the host stops sending sentences however, sentences from the inputs, SeaTalk and NMEA 2000 will be routed to the output again after a time out of 10 seconds.

The **Override** option is very useful when navigating alternately using a GPS and navigation software. Consider a typical set-up as shown in Figure 19 with Out1 set to **Override**:

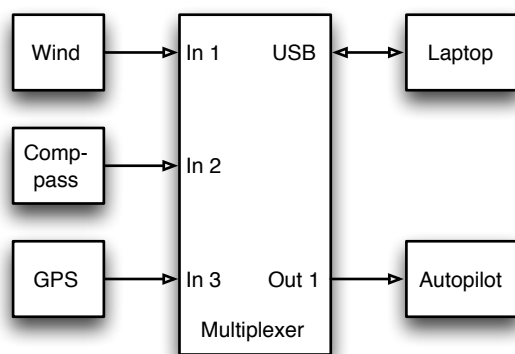

Figure 19

The connected laptop will receive all data from the instruments. If a waypoint or route is activated in the navigation software, it will transmit autopilot-control sentences to the MiniPlex-3PRO. These sentences will be routed to Out1 exclusively. The connected autopilot will therefore receive sentences from the navigation software only.

If the laptop is not connected, or if no route is activated in the navigation software and it is not transmitting any sentences, the MiniPlex-3PRO will automatically route sentences from the inputs to Out1, thus allowing the GPS to control the autopilot.

Output NMEA V1.5

NMEA Out2 has an option to convert specific sentences from NMEA 0183 V2.0 and up to V1.5 format. NMEA 0183 V2.0 and up defines new fields that are added to existing sentences. Also, in NMEA 0183 V1.5 magnetic heading is transmitted using an HDM sentence instead of an HDG sentence.

Some older navigation devices can only process NMEA 0183 V1.5 sentences and refuse to receive/decode newer sentences. If this option is enabled, the MiniPlex-3PRO converts the following sentences to NMEA 0183 V1.5 format:

ABP, BWC, BWR, GGA, GLL, HDG, RMA, RMB, RMC, VBW, VLW, VTG, XTE and ZDA.

The HDG sentence is replaced by an HDM sentence, and in the VTG sentence the decimal point and trailing decimals are removed from both course fields (older B&G equipment requires this).

Note: this option only affects sentences transmitted from NMEA Out2!

Ignore Divisor

This option disables the divisor in a routing table entry for NMEA Out2. When enabled, sentences are transmitted at their original frequency or rate. The divisor is still applied to the same sentences routed to NMEA Out1.

Priority Control

Two settings on the Priority Control panel govern the behaviour of the Priority system: **Check GPS status** and a **Time out** value in seconds.

When the **Check GPS status** option is enabled, the status and mode flags of GPS sentences are checked. If these flags indicate an "invalid" status (e.g. No fix or Simulator mode), the sentence is blocked. This causes the priority system to choose the next available, lower priority source of like sentences. Without this option enabled, the primary GPS must completely fail (i.e. stop transmitting data) before sentences from the secondary GPS are passed.

Sentences checked for valid status and mode flags are APB, GGA, GLL, RMA, RMB, RMC, VTG and XTE. In addition, the heading field of HDT sentence is checked. Since the HDT sentence has no status flag, GPS compasses generally leave the heading field blank when a GPS fix is lost.

NMEA 2000 PGNs which contain a status field, such as PGN 129209 (GNSS Position) are also checked.

The **Time out** setting determines when a similar sentence of the next lower priority source will be passed. The time out can be set from 1 to 30 seconds.

Options

On this tab, several options can be enabled as well as NMEA 0183 sentences that are generated from NMEA 2000 and SeaTalk.

The screenshot shows a software interface with several tabs: 'NMEA Inputs/Outputs', 'Options' (selected), 'Conversions', 'Routing', and 'NMEA 2000'. The 'Options' tab is divided into two main sections. The left section, 'General Options', contains five checkboxes: 'AIS Own Position to GPS data' (checked), 'Modbus', 'Raw SeaTalk (PSMDST)', 'SeaTalk depth in meters', and 'TAG Blocks'. Below this is a 'Unique ID' field containing 'MX00'. The right section, 'NMEA 0183 Generation from NMEA 2000 and SeaTalk', is further divided into 'GPS', 'Autopilot', and 'System Time'. Under 'GPS', 'RMC' and '10 Hz' are checked. Under 'Autopilot', 'RMB' is checked. Under 'System Time', 'ZDA/PGN 126992' is unchecked. Below these are 'Miscellaneous' options: 'VBW/VHW (Speed) at 10 Hz' (unchecked), and three dropdown menus: 'Attitude: XDR', 'Depth: DPT', and 'True heading: HDT'.

Figure 20

General Options

AIS Own Position to GPS data.

This option converts the so-called *Own Vessel Report* received from an AIS transponder to GPS data. The Own Vessel Report may be received on NMEA 0183 or NMEA 2000. The converted GPS data is transmitted from virtual input **Conversions** on NMEA 0183, NMEA 2000 and - when enabled - via the routing table on SeaTalk.

The own vessel position report only contains latitude, longitude, course and speed over ground. No time and date are available. Therefore, the generated GPS position does not have a time or date of fix.

Modbus

Modbus is a widely used industrial protocol between PLCs (Programmable Logic Controllers) and sensors. The MiniPlex-3PRO can read data from such sensors and convert the sensor readings into NMEA 0183 \$YXXDR sentences. When this option is enabled, a **Modbus** tab will be available and NMEA Out4 becomes a Modbus RTU (RS485) port to which Modbus sensors can be connected.

The **Modbus** tab contains the Modbus Slave table and controls to manage that table. The Modbus feature is described in detail in chapter **Modbus** on page 49.

Raw SeaTalk (PSMDST)

This option enables conversion of SeaTalk datagrams to \$PSMDST sentences containing the unconverted "raw" SeaTalk data. The \$PSMDST sentence contains hexadecimal numbers for each byte of the original SeaTalk datagram. For normal use of the MiniPlex-3PRO, this option should be left disabled as it is only intended for either diagnostic purposes or for software developers who want to have access to all available SeaTalk datagrams on the network.

For an in-depth technical explanation of this option, see paragraph **Converted SeaTalk Datagrams** in the Technical Reference in the back of this manual.

SeaTalk Depth in meters

When depth information from NMEA 0183 or NMEA 2000 is converted and routed to SeaTalk, this option will instruct displays on the SeaTalk network to show the depth in meters instead of feet.

Suppress Pinning

Modern GPS receivers may not transmit course over ground and even speed over ground when the GPS is not moving. This is called *pinning*. When a GPS is stationary, a COG cannot be determined, thus it has a random value while the SOG might be either 0 or a very small but varying value. Pinning suppresses these random values by marking the data as "not available" in NMEA 2000 or by leaving the COG field, and sometimes the SOG field too, in the RMC sentence empty.

Some NMEA 0183 repeater displays may not show GPS information if the COG and/or SOG fields are empty. When the **Suppress Pinning** option is enabled, the MiniPlex-3PRO will fill empty COG and SOG fields of an RMC sentence with "0.0" to keep repeater displays happy.

TAG Blocks

This option prepends each sentence with a Source TAG block. This TAG block contains a source identification parameter, identifying the source of that sentence. Figure 21 shows a few sentences prepended with TAG blocks.

```
\s:MX63-2*46\IIGGA,143357.999,5301.0061,N,00635.5479,E,1,06,1.9,90.0,M,,0000*2E
\s:MX63-3*45\GPGGA,143357.999,5301.0061,N,00635.5479,E,1,06,1.9,90.0,M,,0000*39
\s:MX63-2*46\IIGLL,5301.0061,N,00635.5479,E,143357.999,A*22
\s:MX63#1B*09\HEHDT,67.0,T*1E
```

Figure 21

The TAG blocks in first three lines identify an NMEA 0183 input with one digit after a dash whereas the TAG block in last line identifies an NMEA 2000 source with its hexadecimal Source Address after the hash sign.

TAG blocks can be useful if multiple MiniPlex-3PRO multiplexers are connected to a network. Receiving devices/software can decode a TAG block to determine the source of an NMEA 0183 sentence on the network.

MPXConfig3Pro enables TAG blocks temporarily for the duration of the connection and uses the source information for filling the routing table during a Capture or to selectively show NMEA sentences in the NMEA viewer

See the **Technical Reference** in the back of this manual for a description of TAG blocks.

Unique ID

The Unique ID is a text string which is placed in a Source TAG block. When no Unique ID is entered or the existing Unique ID is erased, a default Unique ID is set. The default Unique ID is "MXnn" where *nn* are the last two digits of the serial number of the MiniPlex-3PRO.

NMEA 0183 Generation from NMEA 2000 and SeaTalk

This section controls which NMEA 0183 sentences are generated from NMEA 2000 and SeaTalk data. The factory default settings are sufficient for most applications.

When connected devices require other sentences, they can be enabled here. For instance, a VHF radio might require a GGA sentence for GMDSS, instead of an RMC sentence. Similarly, some autopilots are known to require APB and XTE in addition to the RMB sentence to operate properly.

Option **GSx** enables both GSA and GSV sentences. Option **BWx** enables either BWC or BWR, depending on PGN 129284, field 6 (Calculation Type). If the Calculation Type is Rhumb Line, a BWR sentence is generated. In all other cases (Great Circle or Not Available) a BWC sentence is generated.

10 Hz

This option sets the frequency of the RMC, GGA, GLL and VTG sentence to 10 Hz. This will result in 10 position updates per second, taking advantage of NMEA 2000 PGN 129025, *Position, Rapid Update*, which is also transmitted at 10 Hz. The COG and SOG values in the RMC and VTG sentences will be updated at 4Hz, which is the frequency of PGN 129026, *COG & SOG, Rapid Update*.

Be careful when routing these sentences to NMEA outputs that operate at a slow speed: A single RMC sentence at 10Hz will certainly overflow an output at 4800 Baud! In such a case, create an entry for this sentence in the routing table and use the **Divisor** to reduce the frequency.

System Time – ZDA/PGN 126992

This option will enable the output of a ZDA sentence or PGN 126992 containing *System Time*. The MiniPlex-3PRO features an internal real-time clock which can be set from a time source or be free running. This clock will be set when a system time is received from either NMEA 2000, NMEA 0183 or SeaTalk. The system time will never be retransmitted on the same bus or protocol it was received from.

For example: if the System Time was received from an NMEA 0183 RMC or ZDA sentence, the MiniPlex will only transmit the System Time on NMEA 2000 and SeaTalk.

The priority of the System time in case of multiple sources is, in descending order, NMEA 2000 > NMEA 0183 > SeaTalk.

Both the Source field (2) in PGN 129992 as the Talker ID of the ZDA sentence transmitted by the MiniPlex-3PRO will indicate the source of the System Time.

When a System Time is no longer received, the MiniPlex-3PRO will stop transmitting System Time.

The ZDA sentence is generated internally, originating from the *NMEA Conversions* input and transmitted by default on the host interfaces only. When it needs to be transmitted from one of the NMEA outputs, either the default route from *NMEA Conversions* to Out1 and/or Out2 must be enabled or "--ZDA" must be entered in the routing table, with input **C** and the desired outputs enabled.

PGN 126992 is transmitted from the *Main* device of the MiniPlex-3PRO.

VBW/VHW (Speed) at 10 Hz

This option sets the frequency of the VBW and VHW sentences (speed through water) to 10 Hz.

Attitude

This drop-down menu selects which NMEA sentences are being transmitted for attitude and heave. The default setting is **XDR**. When **PFEC** is selected, the MiniPlex-3PRO will transmit two Furuno Proprietary sentences: \$PFEC,GPhve containing heave and \$PFEC,GPatt containing attitude. These are non-standard NMEA sentences and only recognized by specific Furuno navigation equipment.

Depth

This drop-down menu selects which NMEA sentence (DPT or DBT) is being transmitted when depth is received from an NMEA 2000 or SeaTalk source. The default setting (**DPT**) is the preferred setting because the DPT sentence also contains the transducer offset and the maximum range that can be measured. A DBT sentence is sometimes required by older navigation devices.

True heading

This drop-down menu selects which NMEA sentence (HDT or THS) is being transmitted when true heading is received from an NMEA 2000 source. The Talker ID of the generated sentence depends on the true heading source. In case of a GPS compass the Talker ID will be "GP", "HE" will be used for all other sources.

Conversions

The MiniPlex-3PRO can convert certain NMEA 0183 sentences into new sentences. These can be sentences received on inputs 1 to 4 or sentences created from an NMEA 2000 or SeaTalk source. The original sentence remains unaffected, a conversion always creates a new additional NMEA 0183 sentence.

When the address field of the converted sentence is identical with the original sentence, like a reversed true heading (HDT → HDT), the converted sentence appears on a virtual input called *NMEA Conversions* (column **C** in the routing table). When the address field of the converted sentence differs from its original then the conversion result appears from the same source as the original.

This ensures that a conversion result can always be routed separately from the original sentence.

Note that if the original sentence should be blocked, its entry in the routing table must have a checkbox on the input side of the table but no checkbox on the output side. The checkbox on the input side ensures the sentence is passed to the conversion function.

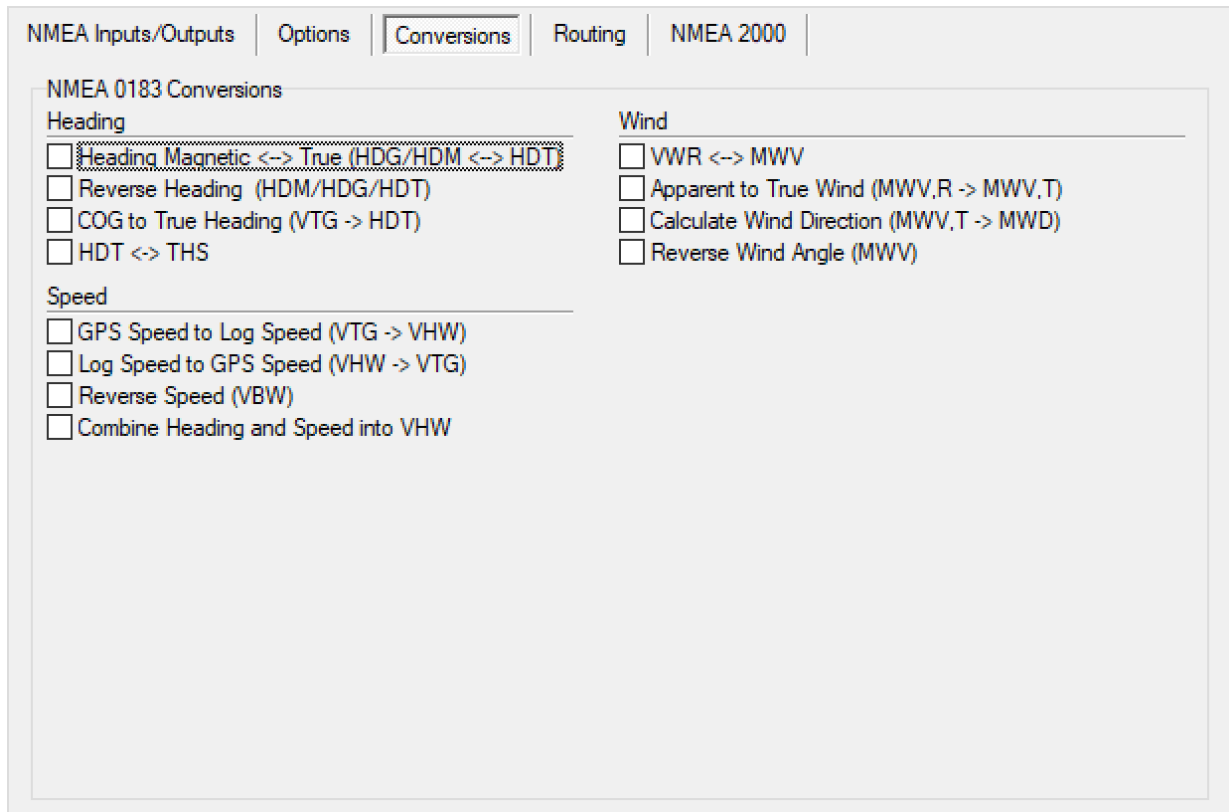

Figure 22

Heading

Heading Magnetic ↔ True (HDG/HDM ↔ HDT)

This option converts magnetic to true heading and vice versa. If the MiniPlex-3PRO receives an HDG or HDM sentence (magnetic heading), it will generate an HDT sentence (true heading). If the multiplexer receives an HDT sentence, it will generate an HDM sentence.

If the originating HDG sentence contains magnetic variation and/or deviation, these are used to calculate a true heading from the magnetic heading. Otherwise, the magnetic heading value is just copied. If the originating HDG sentence contains no variation, the MiniPlex-3PRO will use any variation received from an NMEA 0183, NMEA 2000 or SeaTalk source. The variation in the HDG sentence always takes precedence over any other variation.

The resulting conversion originates from the same source as its original.

Reverse Heading (HDM/HDG/HDT/THS)

This option reverses the heading from any received heading sentence. On reception of a heading sentence, the MiniPlex-3PRO transmits a new heading sentence with 180° added to the original heading. This can be used to provide two opposing navigation stations on ferries with a heading from the same source.

The resulting conversion originates from input *NMEA Conversions* (column **C** in the routing table), allowing the original and converted sentences to be routed differently.

The Talker ID in HDT and THS sentences is preserved to ensure compatibility with GPS compasses, which generally output a Talker ID "GP".

COG to True Heading (VTG → HDT)

This option converts a VTG sentence from a GPS into an HDT sentence, using the course over ground to simulate a true heading.

The resulting conversion originates from the same source as its original.

HDT ↔ THS

This option converts an HDT sentence into a THS sentence and vice versa. The Talker ID in HDT and THS sentences is preserved to ensure compatibility with GPS compasses, which generally output a Talker ID "GP".

The resulting conversion originates from the same source as its original.

Speed

GPS Speed to Log Speed (VTG → VHW)

This option converts a VTG sentence from a GPS into a VHW sentence, using the speed over ground to simulate a speed through water. This option can be useful to simulate a log with a stuck paddlewheel.

The resulting conversion originates from the same source as its original.

Log Speed to GPS Speed (VHW → VTG)

This option converts a VHW sentence from a speed log into a VTG sentence, using the speed through water to simulate a speed over ground. This can be useful if a device needs a VTG sentence while only a Log is available.

The resulting conversion originates from the same source as its original.

Reverse Speed (VBW)

This option reverses/changes the sign of all speed fields in a VBW sentence.

The resulting conversion originates from input *NMEA Conversions* (column **C** in the routing table), allowing the original and converted sentences to be routed differently.

Combine Heading and Speed into VHW

This option combines magnetic and/or true heading from any source with speed through water from any source into a VHW sentence. Where the resulting VHW sentence originates from, depends on the source of the speed through water: if the source is a VHW sentence, NMEA 2000 or SeaTalk, then the converted VHW sentence originates from input *NMEA Conversions*. If the source is an NMEA 0183 VBW sentence, then the converted VHW sentence originates from the same input.

Wind

VWR ↔ MWV

This option converts a VWR sentence into an MWV sentence and vice versa. Sometimes software expects one sentence while the available wind instrument generates the other. By enabling this option, "old" and "new" can be connected without problems.

The resulting conversion originates from the same source as its original.

Apparent to True Wind (MWV,R → MWV,T)

This option converts apparent wind (AWA/AWS) into true wind (TWA/TWS) using the STW from any available source of water speed.

The resulting conversion originates from the same source as its original.

If only VWR sentences are available, the **VWR ↔ MWV** option can be enabled to convert these to MWV sentences first.

Calculate Wind Direction (MWV,T → MWD)

This option converts true wind angle into true wind direction using any magnetic and true heading source. If only apparent wind is received, option **Apparent to True Wind** can be enabled to provide true wind.

The resulting conversion originates from the same source as its original.

Reverse Wind Angle (MWV)

This option reverses the wind angle in an MWV sentence.

The resulting conversion originates from input *NMEA Conversions* (column **C** in the routing table), allowing the original and converted sentences to be routed differently.

Routing

The routing table is the most powerful feature of the MiniPlex-3PRO. It allows NMEA 0183 sentences to be filtered and routed based on their Address Field and source, and optionally reduce their rate or frequency when routed to one of the NMEA 0183 outputs.

The routing table stores up to 50 entries, either entered manually or by capturing the NMEA 0183 sentences received/generated by the multiplexer.

NMEA 2000 and SeaTalk data is also routed here, though not based on their PGN or datagram number but by the equivalent NMEA 0183 sentence they are converted to.

	Inputs								NMEA 2000 Sources		Sentence	Div	Outputs							
	1	2	3	4	5	6	7	8	C	H			N	Device	1	2	3	4	ST	H
1											<input checked="" type="checkbox"/>	HDS Gen2 5m iGPS	GPRMC	<input checked="" type="checkbox"/>						<input checked="" type="checkbox"/>
2	<input checked="" type="checkbox"/>												HEHDT		<input checked="" type="checkbox"/>					<input checked="" type="checkbox"/>
3											<input checked="" type="checkbox"/>		SDDPT							<input checked="" type="checkbox"/>

Figure 23

Each entry in the routing table contains the Address Field of an NMEA sentence, checkboxes to specify its source and destination and a divisor factor to reduce the sentence rate or frequency.

Routing Table Columns

The routing table contains the following columns:

Index: The leftmost column is the entry number. Clicking on a number enables the **Delete** button to delete the entry.

Inputs:

- 1-8: NMEA 0183 inputs 1 to 8. If In 1 is set to SeaTalk, the "1" changes into "ST"
- C: NMEA 0183 Conversion results
- H: Input from the host port
- N: Input from the NMEA 2000 port

Device: Source device of the NMEA 2000 data

Sentence: The Address Field of an NMEA 0183 sentence. This fully specifies the type of NMEA sentence to be filtered or routed. A "-" (dash) matches any character in the Address Field. For instance, if an entry contains "--GLL", any sentence that ends on GLL will match, regardless of its Talker ID (the first two characters). Similarly, a "P----" will match on every proprietary sentence starting with \$P. The Sentence field must contain 5 characters.

Div: Divisor field. A number from 1 to 99 will divide the sentence rate or frequency by the number entered. If this field contains a divisor of 5 for instance, every fifth occurrence of this sentence will be passed. The divisor is not applied to the host outputs and to SeaTalk¹. Also, the divisor can be disabled for NMEA Out 2

Outputs:

1-4: NMEA outputs 1 to 4
ST: Output to SeaTalk port²
H: Output to host port

Note 1: SeaTalk data is transmitted using fixed time slots, independent of the rate of the originating data received on NMEA 0183 or NMEA 2000. The Divisor has no influence on this.

Note 2: This column is only enabled if In1 is set to SeaTalk mode.

There is no output column for NMEA 2000. All received NMEA 0183 and SeaTalk data is always converted and routed to the NMEA 2000 network.

Table Buttons and Controls

The following controls are available to edit the table:

Capture: Enables capture mode. The table will be filled automatically with NMEA 0183 sentences currently received by the MiniPlex-3PRO.

Add: Add a new empty entry at the end of the table.

Delete: Delete an entry from the table in MPXConfig3Pro. Click on the Index number of the entry to be deleted. This will enable the **Delete** button.

Clear: This button clears the table in MPXConfig3Pro (not in the MiniPlex-3PRO!). To clear the table in the MiniPlex-3PRO, click on the **Store** button after clearing the table in MPXConfig3Pro.

Store: Stores the table from MPXConfig3Pro into the MiniPlex-3PRO. This overwrites the table inside the MiniPlex-3PRO.

No Match: This setting determines what happens if a received sentence is not found in the routing table. Set to **Default** to apply the default route or **Block** to block the sentence.

Editing the table

It is important to keep in mind that all modifications and additions are made to the routing table in MPXConfig3Pro only. The current table is automatically loaded from the MiniPlex-3PRO to MPXConfig3Pro when you connect to the MiniPlex-3PRO or when you click on the **Read Configuration** button. After editing, the table must be stored in the MiniPlex-3PRO using the **Store** button to be effective.

Inputs/Outputs: Clicking on a checkbox in an **Inputs** or **Outputs** column enables a sentence from that input or to that output.

Device: The **Device** field can be filled by double-clicking on the field and selecting the desired NMEA 2000 device from the window that appears. The **Device** field can be cleared again by selecting it and pressing the Delete key on your keyboard.

Sentence/Div: The **Sentence** and **Divisor** fields can be edited by selecting it with the cursor. Edit mode is entered in several ways:

- Press function key F2 on your keyboard. This enters Edit mode with the cursor at the end of the text. Move the cursor around with the mouse or arrow keys.
- Press Enter or click with the cursor: This enters Edit mode with the text selected and the cursor at the first character. Any character or number that is typed now will erase the existing text entirely unless the cursor is moved around with the mouse or arrow keys. This will unselect the text.

When changes are made, press Enter to confirm them or press Escape to discard any changes and exit Edit mode.

Note on editing tables

All tables in MPXConfig3Pro (Routing and Modbus) operate in the same way. The buttons **Add**, **Delete**, **Clear** and **Store** on these tabs operate in the same way, as well as editing text fields.

Filling the table

The routing table can be filled in two ways: Use the **Add** button to add entries to the table or the **Capture** button to fill the table with sentences currently being received. When using **Capture**, ensure

the routing table inside the MiniPlex-3PRO is cleared first by clicking on **Clear** and **Store**. Otherwise, you would be capturing data which is already routed or filtered.

All controls will be disabled during capture and the **Capture** button changes to **Stop**. Leave the capture mode running for approximately 10 seconds. By that time, all connected devices will have transmitted NMEA sentences, which are now stored in the routing table in MPXConfig3Pro. Click on **Stop** to end the capture mode.

The captured entries will have checkboxes in the input columns, indicating the source of each entry.

It is absolutely necessary to review and modify the routing settings for each sentence after a Capture. Use the routing table with care! Simply capturing the table and storing it unmodified is useless and can lead to unforeseen problems!

The general advice is to remove entries from single sources that should be routed to a host only. The Default Route already takes case of these sentences. The two main reasons for using the routing table are:

1. Route specific sentences to an NMEA 0183 output
2. Block duplicate sentences

The **Technical Reference** lists commonly used Talker ID's and Sentence Formatters. These lists can be a useful aid while setting up the routing table as they explain the nature of the sentences and which information they contain.

It is very important to realize that using a capture to fill the table overrides the default routes since every sentence is in the routing table.

NMEA 2000 Sources

A checkbox in the **N** column and an empty **Device** field will pass that sentence from every device on the NMEA 2000 network. Using only the checkbox is sufficient in case of a single source of each sentence.

When multiple sources of the same sentence exist, use the **Device** field to select the source of that sentence. To add a device, double-click on the **Device** field of the desired routing entry. This will open a window showing all devices on the NMEA 2000 network:

Manufacturer	Model ID	Serial No.	Version	LE (mA)	SA	DI	SI
ShipModul	MiniPlex-3E-N2K - Main	F0000324	3.0.0	50	0	0	0
ShipModul	MiniPlex-3E-N2K - In1	F0000324	3.0.0	0	1	0	0
ShipModul	MiniPlex-3E-N2K - In2	F0000324	3.0.0	0	2	0	0
ShipModul	MiniPlex-3E-N2K - In3	F0000324	3.0.0	0	3	0	0
ShipModul	MiniPlex-3E-N2K - In4	F0000324	3.0.0	0	4	0	0
ShipModul	MiniPlex-3E-N2K - Cnv	F0000324	3.0.0	0	5	0	0
Actisense	NMEA 2000 PC Interface (NGT-1)	147824	1.100	50	15	0	0
Lowrance Electronics, Inc.	HDS Gen2 5m Pilot Controller	3257260698	4.0.45.2.200	0	26	0	0
Lowrance Electronics, Inc.	HDS Gen2 5m iGPS	3257260698	4.0.45.2.200	0	27	0	0
Lowrance Electronics, Inc.	HDS Gen2 5m Navigator	3257260698	4.0.45.2.200	0	28	0	0
Lowrance Electronics, Inc.	HDS Gen2 5m MFD	3257260698	4.0.45.2.200	50	29	0	0
Raymarine	SeaTalk-STNG-Converter	0390997	2.03	50	117	25	1

Figure 24

Double-click on the desired entry or select it and click on the **OK** button to save the device into the routing table. Clicking the **Cancel** button leaves the routing table untouched. The **Refresh** button performs a re-scan of all devices on the NMEA 2000 network. The latter would only be required if a message appears that new NMEA 2000 devices have been detected.

Routing Operation

When the MiniPlex-3PRO receives an NMEA 0183 sentence or creates one from an NMEA 2000 or SeaTalk source, it searches the routing table for a match in the order as the entries appear in the table in MPXConfig3Pro.

If a match is found (address field and input/source match), the sentence is accepted for further processing and routing. If only the address field matches, the search continues until a full match is found or the end of the table is reached.

If no match is found, the **No Match** setting determines what happens next: when set to **Default**, the default route is applied. When it is set to **Block**, the sentence is blocked.

The default routes are set in section **Input Settings** on the **NMEA Inputs/Outputs** tab.

Note that the MiniPlex-3PRO will not pass any sentence if the routing table is empty and the **No Match** setting is set to **Block**.

Received NMEA 0183 sentences are following a specific processing route, as shown in Figure 25 below:

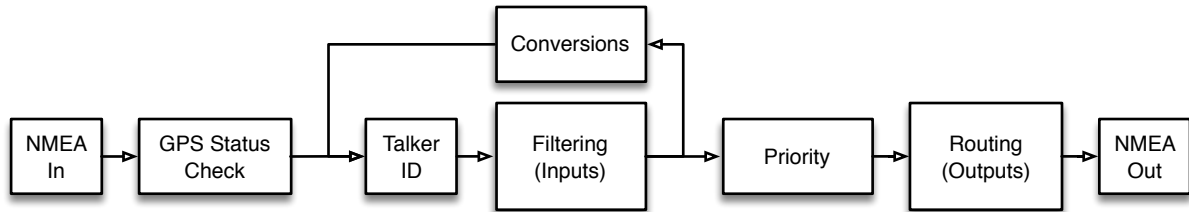

Figure 25

A few important things can be seen from this figure:

- The GPS Status check blocks a GPS related sentence at this point if its status flags are set to “invalid” in case of no GPS fix. This will trigger the Priority block further up in the chain to pass a lower priority source.
- If a Talker ID is set for an input, it is applied to received NMEA sentences *before* filtering is applied. A routing entry must therefore contain the correct Talker ID.
- Conversions are applied *after* filtering. As a result, sentences that are blocked on an input will not be converted. This implies that if a sentence must be converted and only the conversion result is required, the originating sentence must be enabled on the receiving input and blocked on all outputs. The conversion result needs to be enabled on the **C** input and routed to the desired output.

Example

Figure 26 shows a small routing table:

	Inputs											NMEA 2000 Sources		Outputs						
	ST	2	3	4	5	6	7	8	C	H	N	Device	Sentence	Div	1	2	3	4	ST	H
1	✓												GPRMC		✓					
2		✓											HEHDT	5		✓			✓	✓
3											✓		WIWMV							✓
4											✓		WIMTW							✓
5	✓												VWVHW							✓
6											✓		AIVDM			✓				✓
7											✓	HDS Gen2 5m iGPS	GPRMC							✓
8											✓	HDS Gen2 5m Naviga...	GPRMB							✓

Figure 26

These entries have the following effect:

1. GPRMC sentences received from SeaTalk are routed to output 1.
2. HEHDT sentences received from input 2 are routed to SeaTalk and the host port. Only every 5th sentence is passed to Out2.
3. WIWMV sentences received from any NMEA 2000 source are routed to the host port.
4. WIMTW sentences received from any NMEA 2000 source are routed to the host port.
5. VWVHW sentences received from SeaTalk are routed to the host port.
6. AIVDM sentences received from any NMEA 2000 source are routed to Out2 and the host port.
7. GPRMC sentences received from the HDS Gen2 5m iGPS are routed to the host port.
8. GPRMB sentences received from the HDS Gen2 5m Navigator are routed to SeaTalk.

Note that entries 7 and 8 apply to the same Lowrance HDS Gen2 5m chart plotter. Most chart plotters present multiple virtual devices on the NMEA 2000 network, as can be seen in the NMEA 2000 Devices window in Figure 24. In this case, one device is the GPS and the other device is the Navigator - the source that transmits PGNs used for controlling an autopilot.

NMEA 2000

In general, it is not necessary to change any of the settings on this tab. If all devices on the NMEA 2000 network receive the converted NMEA 0183 from the MiniPlex-3PRO, everything is just fine.

The MiniPlex-3PRO announces itself on an NMEA 2000 as ten *virtual* devices: one *Main* device, and one device for each NMEA 0183/SeaTalk input and the conversion results. Each device has its own Device Type, Source Address and Device Instance.

Source Addresses are allocated automatically during the Address Claim Procedure each device performs during start-up, or if an address contention occurs when another device claims the same Source Address.

The Address Claim Procedure ensures that each device on the NMEA 2000 has a unique Source Address. This unique Source Address, which is attached to every message transmitted onto the NMEA 2000 network, ensures that receiving devices can distinguish similar data from different devices. The Source Address is key for a working data source selection.

The screenshot shows a software interface for NMEA 2000 configuration. At the top, there are tabs for 'NMEA Inputs/Outputs', 'Options', 'Conversions', 'Routing', and 'NMEA 2000'. The 'NMEA 2000' tab is selected. Below the tabs, there are two main sections. On the left, 'Device Settings' contains a table with columns for 'Device Type', 'SA', and 'DI'. The rows are labeled 'Main:', 'In 1:', 'In 2:', 'In 3:', 'In 4:', 'In 5:', 'In 6:', 'In 7:', 'In 8:', and 'Conv:'. Each row has a dropdown menu for 'Device Type' and two input boxes for 'SA' and 'DI'. On the right, 'Generate \$MXPGN' has two checkboxes: 'From unknown PGN's' and 'From all PGN's'. Below these is a 'Device List' button with a magnifying glass icon.

	Device Type	SA	DI
Main:	PC Gateway	2	0
In 1:	NMEA 0183 Gateway	13	0
In 2:	NMEA 0183 Gateway	14	0
In 3:	NMEA 0183 Gateway	12	0
In 4:	NMEA 0183 Gateway	16	0
In 5:	NMEA 0183 Gateway	17	0
In 6:	NMEA 0183 Gateway	18	0
In 7:	NMEA 0183 Gateway	19	0
In 8:	NMEA 0183 Gateway	20	0
Conv:	NMEA 0183 Gateway	21	0

Figure 27

Device Settings

The settings in this section control how each virtual device of the MiniPlex-3PRO is identified on the NMEA 2000 network.

Device Type

Each device on an NMEA 2000 network has a *Device Class* and *Device Function* code. These codes enable other devices to make an automatic "best choice" for a data source.

In MPXConfig3Pro, a **Device Type** can be selected for the *Main* device and each of the NMEA 0183 inputs. Selecting a **Device Type** sets the right Device Class and Device Function code for each virtual MiniPlex-3PRO device. In general, it is not necessary to change any of the settings on this tab; the default Device Types are fine in most situations.

In some cases however, it might be convenient (1) or even required (2) to set a **Device Type** that matches with the device connected to the NMEA 0183 input:

- 1) An AIS transponder and a GPS are connected to two NMEA 0183 inputs of the MiniPlex-3PRO and a plotter is connected to the NMEA 2000 network. This plotter will see two similar sources of GPS data, both originating from an **NMEA 0183 Gateway**. The plotter will randomly decide which

source to use.

By setting the AIS input to **AIS** and the GPS input to **Ownship Position (GNSS)**, that same plotter could make an “educated” decision to use the GPS as data source for position data and fall back to the AIS in case the GPS fails.

- 2) A GPS is connected to an NMEA 0183 input of the MiniPlex-3PRO and a GMDSS capable VHF radio is connected to the NMEA 2000 network. Some radios are known to only accept position data from a GPS device for safety reasons. They do not accept position data from any other source such as an NMEA 0183 gateway. In this case, it is necessary to set the Device Type of the NMEA 0183 input of the MiniPlex-3PRO to **Ownship Position (GNSS)**.

Some Device Types are marked with “(< V2)”. In the transition from V1.300 to V2.000 of the NMEA 2000 standard, some Device Class and Device Function codes were changed. Older devices supporting NMEA 2000 V1.300 may therefore not recognize V2.000 Device Class and Device Function codes.

The “(< V2)” Device Types can then be used to ensure backwards-compatibility with older NMEA 2000 devices.

SA (Source Address)

This column shows the Source Address claimed by each virtual MiniPlex-3PRO device. This Source Address identifies the NMEA 2000 data each input transmits on the NMEA 2000 network.

Other devices on the NMEA 2000 network use these addresses to specifically select a MiniPlex-3PRO input/virtual device as data source. These Source Addresses listed are allocated automatically on start-up of the MiniPlex-3PRO and/or the NMEA 2000 network.

A “n/a” at any of the inputs indicates that the input couldn’t claim a Source Address and it will not transmit any data on the NMEA 2000 network. To resolve this, enter command PSMDRESET in **Send NMEA** to reset the MiniPlex-3PRO. This will start the Address Claim Procedure and after a moment all inputs should have claimed a Source Address. If “n/a” still shows up, there is a problem on the NMEA 2000 network.

Setting a Source Address

There is one case in which setting a Source Address is required: On a Raymarine SeaTalk^{NG} network, Source Addresses are used to determine the priority of a data source: a higher Source Address implies a higher priority of the data source.

When a fast or high precision heading sensor with an NMEA 0183 output is connected to a SeaTalk^{NG} network through a MiniPlex-3PRO (or any other NMEA 0183/2000 gateway), A Raymarine autopilot system will generally ignore this heading source and use the heading source of the autopilot system instead. By setting the Source Address of the MiniPlex-3PRO input that receives this heading to a high value like 200, the Raymarine autopilot will accept the heading from the MiniPlex-3PRO. The highest Source Address that can be entered, is 251.

There is no guarantee that a given Source Address is also obtained. If the MiniPlex-3PRO tries to claim a given Source Address, another device on the network may already have claimed this Source Address. If this is the case, the numerical value (NAME) in the Address Claim message that both devices will transmit on the NMEA 2000 network determines who “wins” this address. The device losing this claim must then claim a new Source Address. If the MiniPlex-3PRO wins, the entered Source Address will remain the same, otherwise a different value may appear. The NMEA 2000 Device List (Figure 28) can be used as a guide to find a free or unused Source Address.

DI (Device Instance)

Every device on an NMEA 2000 network has a Device Instance: a number with a valid range from 0 to 255, providing a means to enumerate the number of like devices (same Class and Function codes) on the NMEA 2000 network.

The DI of each NMEA 0183 input can be set to provide this enumeration. For instance, if two depth sensors are connected to two NMEA 0183 inputs of the MiniPlex-3PRO, assigning different DIs to each input allows other devices to enumerate both depth sensors.

The NMEA 2000 numbering convention is to start from 0, incrementing from port side of the vessel to starboard, then from bow to stern.

The default Device Instance value is 0 and it is not necessary to change it if no NMEA 0183 input receives the same data.

Generate \$MXPGN

The options in this section control if and when \$MXPGN sentences are generated by the MiniPlex-3PRO. These sentences contain the PGN number, an attribute field and the binary data of the PGN, all represented as hexadecimal ASCII numbers:

```
$MXPGN,01F112,2807,FC7FFF7FFF168012*11
```

See the **Technical Reference** section for a description of the \$MXPGN sentence and how it can be used.

From unknown PGNs

Unknown PGNs are PGNs which are not converted to NMEA 0183 sentences. When this option is enabled, only unknown PGNs are converted into \$MXPGN sentences.

This option can be useful when navigation software needs to read PGNs for which no equivalent NMEA 0183 sentence exists. Such PGNs could contain an electrical switch position or *proprietary data*. Converting these PGNs to \$MXPGN sentences allows developers to easily read NMEA 2000 data using existing NMEA 0183 sentence parsing code.

From all PGNs

When this option is enabled, the conversion from NMEA 2000 PGNs to NMEA 0183 sentences is completely disabled and every received NMEA 2000 PGN is converted into one or more \$MXPGN sentences. This allows software on a PC to read and decode every possible NMEA 2000 PGN.

It is also possible to send an \$MXPGN sentence to the MiniPlex-3PRO using an NMEA 0183 input or host interface. The MiniPlex-3PRO will then convert this to an NMEA 2000 PGN and transmit it onto the NMEA 2000 network, provided the Write bit in the attribute field of the \$MXPGN sentence is set to '1'.

When support is requested, we often ask you to enable this option prior to generating an NMEA log file. This allows us to "replay" your NMEA 2000 data onto the NMEA 2000 network in our office, to duplicate the problems you encounter.

Device List

This button opens a window showing all devices that are present on the NMEA 2000 network.

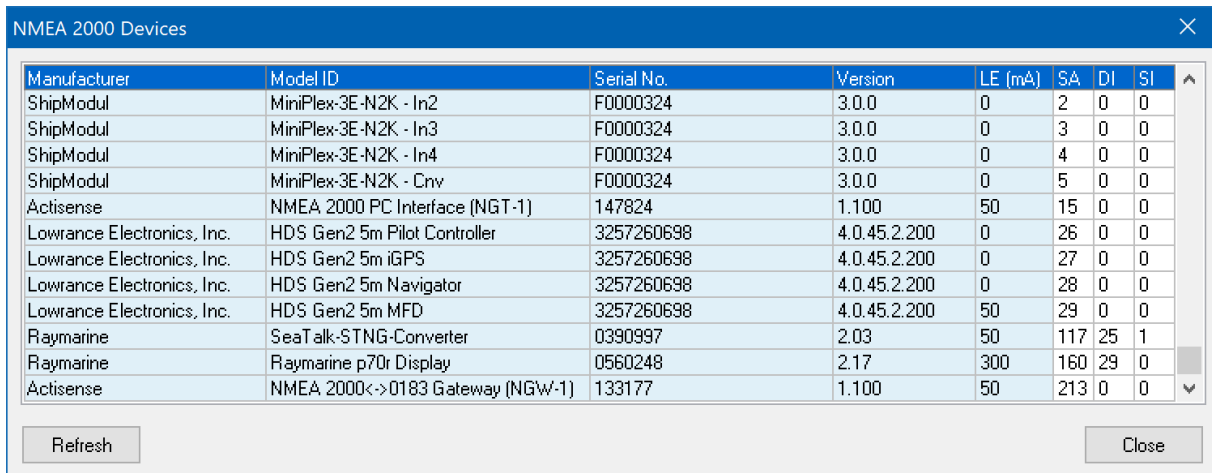

Manufacturer	Model ID	Serial No.	Version	LE (mA)	SA	DI	SI
ShipModul	MiniPlex-3E-N2K - In2	F0000324	3.0.0	0	2	0	0
ShipModul	MiniPlex-3E-N2K - In3	F0000324	3.0.0	0	3	0	0
ShipModul	MiniPlex-3E-N2K - In4	F0000324	3.0.0	0	4	0	0
ShipModul	MiniPlex-3E-N2K - Cnv	F0000324	3.0.0	0	5	0	0
Actisense	NMEA 2000 PC Interface (NGT-1)	147824	1.100	50	15	0	0
Lowrance Electronics, Inc.	HDS Gen2 5m Pilot Controller	3257260698	4.0.45.2.200	0	26	0	0
Lowrance Electronics, Inc.	HDS Gen2 5m iGPS	3257260698	4.0.45.2.200	0	27	0	0
Lowrance Electronics, Inc.	HDS Gen2 5m Navigator	3257260698	4.0.45.2.200	0	28	0	0
Lowrance Electronics, Inc.	HDS Gen2 5m MFD	3257260698	4.0.45.2.200	50	29	0	0
Raymarine	SeaTalk-STNG-Converter	0390997	2.03	50	117	25	1
Raymarine	Raymarine p70r Display	0560248	2.17	300	160	29	0
Actisense	NMEA 2000<->0183 Gateway (NGW-1)	133177	1.100	50	213	0	0

Figure 28

The most important information of each device on the NMEA 2000 network is listed. More detailed information can be obtained by double-clicking on a device entry. This will open a window as shown in Figure 29.

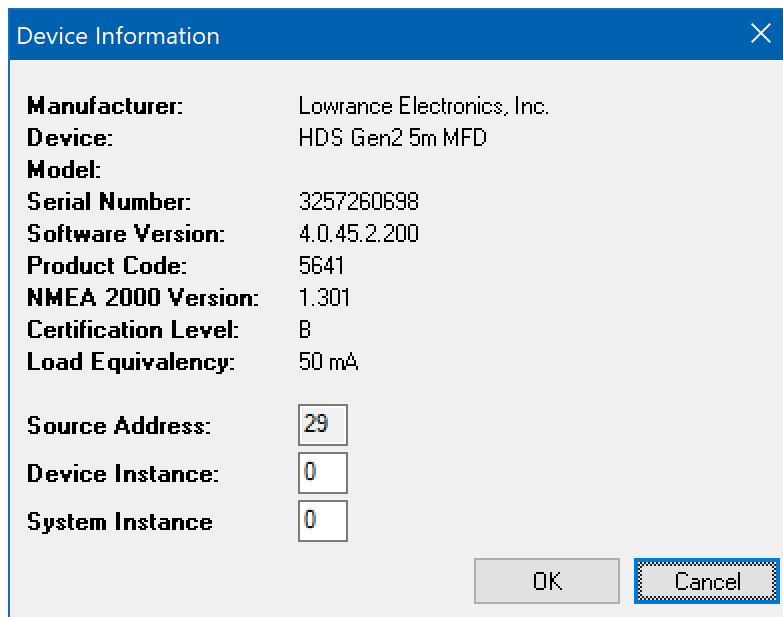

Figure 29

This window shows all available information of a device. The Device Instance and System Instance of a device can be changed to suit the needs of your NMEA 2000 network. In most situations, these settings can be left as they are.

Source Address

The Source Address is allocated dynamically by each device on the NMEA 2000 network and is shown for informational purposes only.

There is one case in which setting a Source Address is required: On a Raymarine SeaTalk^{NG} network, Source Addresses are used to determine the priority of a data source: a higher Source Address implies a higher priority of the data source.

When a fast or high precision heading sensor with an NMEA 0183 output is connected to a SeaTalk^{NG} network through a MiniPlex-3PRO (or any other NMEA 0183/2000 gateway), A Raymarine autopilot system will generally ignore this heading source and use the heading source of the autopilot system instead. By setting the Source Address of the MiniPlex-3PRO input that receives this heading to a high value – such as 200 – the Raymarine autopilot will accept the heading from the MiniPlex-3PRO. The highest Source Address that can be entered, is 251.

There is no guarantee that a given Source Address is also obtained. If the MiniPlex-3PRO tries to claim a given Source Address, another device on the network may already have claimed this Source Address. If this is the case, the numerical value (NAME) in the Address Claim message that both devices will transmit on the NMEA 2000 network determines who “wins” this address. The device losing this claim must then claim a new Source Address. If the MiniPlex-3PRO wins, the entered Source Address will remain the same, otherwise a different value may appear. The NMEA 2000 Device List (Figure 28) can be used as a guide to find a free or unused Source Address. .

Device Instance

The Device Instance is a number with a valid range of 0 to 255, providing a means to enumerate the number of like devices (same Class and Function codes) on the NMEA 2000 network.

The Device Instance of each device can be set to provide this enumeration. For instance, if two depth sensors are connected to the NMEA 2000 network, assigning different Device Instances to each sensor allows other devices to enumerate both depth sensors.

The NMEA 2000 numbering convention is to start from 0, incrementing from port side of the vessel to starboard, then from bow to stern.

The MiniPlex-3PRO can use the Device Instance to determine the priority of a Data Source when the Priority setting of the NMEA 2000 interface is set to **DI** on the **NMEA Inputs/Outputs** tab. A lower value of the Device Instance has a higher priority. A value of 0 excludes a Data Source from the priority evaluation. The value of the Device Instance is compared one-on-one to the set priority of an NMEA 0183 input. See chapter **Priority** for detailed information about the priority feature of the MiniPlex-3PRO.

Note: Some SeaTalk^{NG} devices have a fixed, non-zero Device Instance value which cannot be changed.

System Instance

The System Instance is a number with a valid range of 0 to 15 that indicates the occurrence of devices in additional network segments, redundant or parallel networks or sub-networks. Devices behind a bridge or gateway could be assigned a different (other than 0) Device Instance to indicate that they are on a different network segment. This can be used when multiple NMEA 2000 backbones are installed on larger vessels or in case of a redundant installation while a bridge connects these networks. Thus, an NMEA 2000 device on one network segment knows if another device is on the same network segment or on a redundant or other segment. For single/small networks, the System Instance should be left at 0.

Modbus

Modbus is an industrial protocol, used to read data from multiple (industrial) sensors on a single RS485 network. Modbus enabled sensors typically measure non-navigation-related physical quantities like temperature, pressure, level or flow.

When Modbus is enabled, the MiniPlex-3PRO becomes a Modbus master, utilizing the Modbus-RTU protocol via port **NMEA Out4**. Received sensor data is converted into NMEA 0183 \$YXXDR sentences. The MiniPlex-3PRO will group as many sensor values as possible into one XDR sentence as the maximum sentence length or 82 characters permits. The exact number of sensor values depends on the chosen precision and length of Transducer IDs entered for each slave entry.

Up to 30 slave definitions can be entered in the table on the Modbus tab. Each entry defines one slave address and one register number, along with other parameters regarding the register and data type and the required parameters for the XDR sentence.

The screenshot shows the Modbus configuration tab in a software interface. At the top, there are tabs for 'NMEA Inputs/Outputs', 'Options', 'Conversions', 'Routing', 'Modbus', and 'NMEA 2000'. The 'Modbus' tab is active. Below the tabs is a table with two main sections: 'Modbus Slave' and 'XDR Sentence'. The table has columns for 'Slv', 'Reg', 'T', 'D', 'R', 'P', 'T', 'Transducer ID', 'U', and 'Status'. Two entries are visible: entry 1 with Slv=1, Reg=0, T=H, D=I, R=1, P=R, Transducer ID=Fuel1, U=I, Status=?; and entry 2 with Slv=1, Reg=1, T=H, D=I, R=0, P=E, Transducer ID=Fuel1, U=P, Status=?. To the right of the table are buttons for 'Add', 'Delete', 'Clear', and 'Store'. At the bottom right, there is a checkbox labeled 'Enable Diagnostics'.

Modbus Slave							XDR Sentence		
Slv	Reg	T	D	R	P	T	Transducer ID	U	Status
1	1	0	H	I	1	R	Fuel1	I	?
2	1	1	H	I	0	E	Fuel1	P	?

Figure 30

Modbus Table Columns

The Modbus table contains the following columns:

- Index:** The leftmost column is the entry number. Clicking on a number enables the **Delete** button to delete the entry.
- Slv:** The Modbus slave address of the sensor to be read. Valid addresses are 1 to 247.
- Reg:** The Modbus register number of the sensor to be read. The MiniPlex-3PRO uses 0-based protocol addresses, ranging from 0 to 65535.
- T:** Modbus Register type:
H: Holding register (function code 03)
I: Input register (function code 04)
- D:** Data type:
I: Signed integer (16-bit/1 register)
U: Unsigned integer (16-bit/1 register)
L: Signed long integer (32-bit/2 registers)
F: Floating point (32-bit/2 registers)
- R:** Reverse register order in case of a multi-register read operation (Data types "L" and "F").

- P:** Precision or number of decimals for value in Modbus register (0 to 7).
- T:** Transducer Type character in the generated XDR sentence.
- Transducer ID:** Transducer ID in the generated XDR sentence, maximum 15 characters.
- U:** Units character in the generated XDR sentence.
- Status:** Modbus slave status.

Modbus Slave Addresses

The MiniPlex-3PRO uses Modbus protocol addresses (0-based) and a specified register type, as opposed to PLC addresses (1-based), where the register type is implied by the register number.

The Holding register range from 0 to 9998 corresponds with a PLC address range from 40001 to 49999 whereas the Input register range from 0 to 9998 corresponds with a PLC address range from 30001 to 39999.

Register Order

The **Reverse** option swaps the Modbus registers when a signed long or a float number is read. These 32-bit numbers are stored in two consecutive 16-bit Modbus registers.

The Modbus protocol does not specify a 32-bit data size, so the implementation is left to the device manufacturers.

Usually, 32-bit numbers are stored as Big-endian, where the first register holds the most significant 16 bits and the second register holds the least significant 16 bits. This is in accordance with the Modbus protocol, where 16-bit register values are placed in a Modbus frame as two bytes (octets) in Big-endian order as well.

Some devices however store 32-bit numbers in Little-endian order, where the first register holds the least significant 16 bits and the second register hold the most significant 16 bits. The **Reverse** option will swap these registers in the response frame of the slave.

Precision

The **Precision** sets the number of decimal places for the specified Modbus register and the resulting data field in the XDR sentence. If this field contains 2 for instance, a Modbus register value of 12345 will be represented as 123.45 in the generated XDR sentence.

Slave Status

The **Status** column in the Modbus table indicates the status of a Modbus slave. The colour of the field indicates the severity of the status. The table below lists all possible indications:

?	Status unknown, slave has not been polled
OK	Slave is OK
E xx	Modbus exception xx returned by the slave
SIZE	Slave response has incorrect register count
WSLV	Response from wrong slave received
COM	Communication error (parity, framing or
SIZE	Slave response has an incorrect frame size
CRC	Slave response has a CRC error
NRSP	Slave does not respond

The Modbus exception codes are defined in the "Modbus Application Protocol Specification", which can be found on www.modbus.org.

The **Status** column is not updated "live", it only updates when you click the **Read Configuration** button.

Communication Parameters

The Modbus RTU protocol on the MiniPlex-3PRO utilizes 8 data bits, no parity and 2 stop bits. The baud rate can be set with the **Speed** control for NMEA Out4 on the **NMEA Inputs/Outputs** tab.

Diagnostics

In case of communication problems, checking **Enable Diagnostics** will result in \$PSMDB,D,... and \$PSMDB,E,... sentences containing raw Modbus frame data and error reports respectively. The format of these sentences can be found in the Technical Reference at the back of the manual, section **Proprietary NMEA 0183 Sentences**.

Firmware Update

Firmware updates with new features or bug fixes will be available through our web site. These firmware files can be downloaded to your computer and loaded into the MiniPlex-3PRO using menu **File > Update MiniPlex Firmware**.

MPXConfig3Pro also contains MiniPlex firmware, which is embedded in the application. This firmware is the minimum required version that is compatible with this version of MPXConfig3Pro.

When MPXConfig3Pro connects to the MiniPlex, it will interrogate the currently loaded firmware version and check that against the minimum version required. If the version in the MiniPlex is lower, an update is automatically started. This update can also be forced using menu **Tools > Automatic Update**.

Firmware files always contain a complete firmware version, containing all updates from the previous versions.

Procedure

Ensure you have a working connection from MPXConfig3Pro to the MiniPlex-3PRO. If the MiniPlex-3PRO is configured to use UDP, set it to TCP first. It is not possible to update the firmware using the UDP protocol.

Download the firmware update from our web site and unpack the .zip file. Remember in which folder you stored the .mpx file.

Choose menu **File > Update MiniPlex Firmware**.

Using the file dialog, locate and select the firmware image file. When you have selected the firmware file and clicked on **OK**, the update process starts. The image file's integrity and version are checked first before initiating the download procedure in the MiniPlex-3PRO.

When the download starts, the red LED on the MiniPlex-3PRO will be lit continuously while the green LED blinks on reception of firmware data. MPXConfig3Pro will show a progress indicator during the update process. When the update is complete and successful, a message will show "The firmware update was successful".

Any errors that occur during the process will be shown. It is important to make a note of the error message when asking for support. See **Firmware Update Error messages** for an explanation of the error messages.

Whenever the update process fails, the MiniPlex-3PRO will start transmitting \$PSMDLDR... sentences. This indicates that no firmware is loaded and that the MiniPlex-3PRO is waiting for a new firmware update. Just try updating again until the process is successfully finished.

Sometimes the communication during the firmware update times out and the update is aborted with an error message. When such a time out occurs, the MiniPlex-3PRO has no firmware loaded and it keeps transmitting \$PSMDLDR... sentences, indicating that it is waiting for firmware. Just try updating again until the process is successful. Sometimes it helps to try the update on a different computer.

Mounting

The MiniPlex-3PRO is not waterproof. It should be mounted at a dry place such as behind the instrument panel on a flat surface.

Make sure there is enough space around the MiniPlex-3PRO to connect the wiring at the top, bottom and right side of the housing.

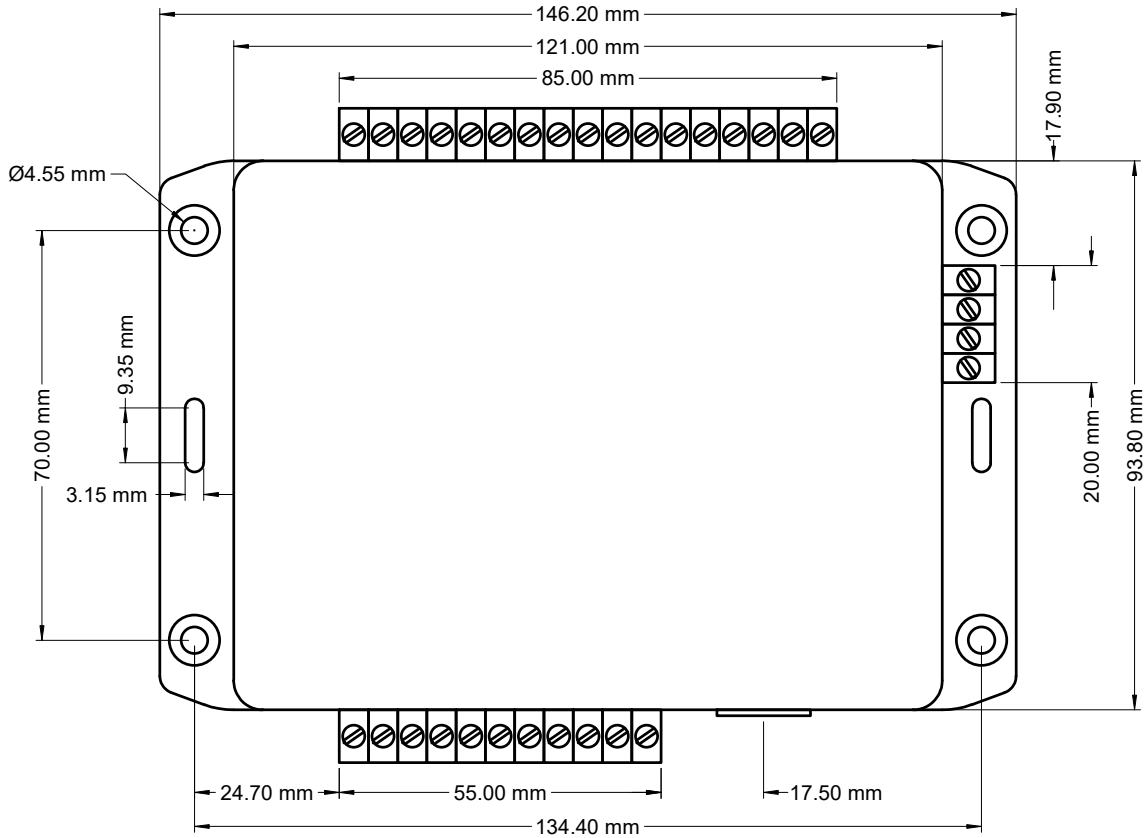

Figure 31: Dimensions

Technical Reference

NMEA 0183 Glossary

This glossary lists the most common Talker ID's and Sentence Formatters in alphabetical order.

Talker ID's

AG	Autopilot (general)
AP	Autopilot (magnetic)
AI	Automatic Identification System
CD	Communications: Digital Selective Calling (DSC)
CR	Data receiver
CS	Satellite
CT	Radio telephone (MF/HF)
CV	Radio telephone (VHF)
CX	Scanning receiver
DE	Decca navigator
DF	Direction finder
EC	Electronic chart systems (ECS)
EI	Electronic chart display and information system (ECDIS)
EP	Emergency position indicating radio beacon (EPIRB)
ER	Engine room monitoring systems
GP	Global Positioning System (GPS)
GL	GLONASS receiver
GN	Global navigation satellite system (GNSS)
HC	Heading sensors: compass, magnetic
HE	gyro, north seeking
HN	gyro, non-north seeking
II	Integrated instrumentation
IN	Integrated navigation
LC	Loran, Loran-C
MX	Multiplexer
P	Proprietary sentence
RA	Radar and/or radar plotting
SD	Sounder, depth
SN	Electronic positioning system, other/general
SS	Sounder, scanning
TI	Turn rate indicator
VD	Velocity sensors: Doppler, other/general
VM	speed log, water, magnetic
VW	speed log, water, mechanical
VR	Voyage data recorder
YX	Transducer
ZA	Timekeepers: atomic clock
ZC	chronometer
ZQ	quartz
ZV	radio updated
WI	Weather instruments

Sentence formatters

AAM	Waypoint arrival alarm
ACK	Acknowledgement alarm
ALM	GPS almanac data
ALR	Set alarm state
APB	Heading/track controller (Autopilot) sentence B
BEC	Bearing and distance to waypoint, dead reckoning
BOD	Bearing, origin to destination
BWC	Bearing and distance to waypoint
BWR	Bearing and distance to waypoint, rhumb line
BWW	Bearing, waypoint to waypoint
DBT	Depth below transducer
DCN	DECCA position
DPT	Depth
DSC	Digital selective calling information
DSE	Expanded digital selective calling

DSI	DSC transponder initialise
DSR	DSC transponder response
DTM	Datum reference
FSI	Frequency set information
GBS	GNSS Satellite fault detection
GGA	Global positioning system fix data
GLC	Geographic position, LORAN-C
GLL	Geographic position, latitude/longitude
GNS	GNSS fix data
GRS	GNSS range residuals
GSA	GNSS DOP and active satellites
GST	GNSS pseudo range error statistics
GSV	GNSS satellites in view
HDG	Heading, deviation and variation
HDT	Heading, true
HMR	Heading monitor – receive
HMS	Heading monitor – set
HSC	Heading steering command
HTC	Heading/track control command
HTD	Heading/track control data
LCD	LORAN-C signal data
MLA	Glionass almanac data
MSK	MSK receiver interface
MSS	MSK receiver signal status
MTW	Water temperature
MWD	Wind direction and speed
MWV	Wind speed and angle
OSD	Own ship data
PGN	NMEA 2000 PGN data
RMA	Recommended minimum specific LORAN-C data
RMB	Recommended minimum navigation information
RMC	Recommended minimum specific GNSS data
ROT	Rate of turn
RPM	Revolutions
RSA	Rudder sensor angle
RSD	Radar system data
RTE	Routes
SFI	Scanning frequency information
STN	Multiple data ID
TLB	Target label
TLL	Target latitude and longitude
TTM	Tracked target message
TXT	Text transmission
VBW	Dual ground/water speed
VDR	Set and drift
VHW	Water speed and heading
VLW	Distance travelled through the water
VPW	Speed, measured parallel to wind
VTG	Course over ground and ground speed
WCV	Waypoint closure velocity
WNC	Distance, waypoint to waypoint
WPL	Waypoint location
XDR	Transducer measurements
XTE	Cross-track error, measured
XTR	Cross-track error, dead reckoning
ZDA	Time and date
ZDL	Time and distance to variable point
ZFO	UTC and time from origin waypoint
ZTG	UTC and time to destination waypoint

Supported NMEA 2000 PGN list

PGN Decimal	PGN Hex	Description	TX	RX
59392	E800	ISO Acknowledge	•	•
59904	EA00	ISO Request	•	•
60160	EB00	ISO Transport Protocol, Data Transfer	•	•
60416	EC00	ISO Transport Protocol, Connection Management	•	•
60928	EE00	ISO Address Claim	•	•
65240	FED8	ISO Commanded Address	•	•
65286	FF06	Fluid Flow Rate (Maretron Proprietary)		•
65330	FF32	Mast Angle (ShipModul Proprietary)	•	
126208	1ED00	Request/Command/Acknowledge group function	•	•
126464	1EE00	Received/Transmitted PGNs group function	•	
126720	1EF00	SeaTalk Data (Raymarine Proprietary)	•	•
126992	1F010	System Time	•	•
126993	1F011	Heartbeat	•	
126996	1F014	Product Information	•	•
126998	1F016	Configuration Information	•	
127237	1F105	Heading/Track Control	•	•
127245	1F10D	Rudder	•	•
127250	1F112	Vessel Heading	•	•
127251	1F113	Rate of Turn	•	•
127252	1F114	Heave		•
127257	1F119	Attitude		•
127258	1F11A	Magnetic variation	•	•
127488	1F200	Engine Parameters, Rapid Update		•
127489	1F201	Engine Parameters, Dynamic		•
127505	1F211	Fluid Level		•
127508	1F214	Battery Status		•
128259	1F503	Speed, Water referenced	•	•
128267	1F50B	Water Depth	•	•
128275	1F513	Distance Log	•	•
129025	1F801	Position, Rapid Update	•	•
129026	1F802	COG & SOG, Rapid Update	•	•
129029	1F805	GNSS Position Data	•	•
129033	1F809	Local Time Offset (V1.300 Time and Date)		•
129038	1F80E	AIS Class A Position Report (msg. 1,2,3)	•	•
129039	1F80F	AIS Class B Position Report (msg. 18)	•	•
129040	1F810	AIS Class B Extended Position Report (msg. 19)	•	•
129041	1F811	AIS Aids to Navigation (AtoN) report (msg. 21)	•	•
129283	1F903	Cross Track Error	•	•
129284	1F904	Navigation Data	•	•
129285	1F905	Navigation - Route/Waypoint information	•	•
129291	1F908	Set & Drift, Rapid Update	•	•
129539	1FA03	GNSS DOP's	•	•
129540	1FA04	GNSS Sats in view	•	•
129793	1FB01	AIS Base Station (msg. 4)	•	•
129794	1FB02	AIS Class A Static and Voyage Related Data (msg. 5)	•	•
129798	1FB06	AIS SAR Aircraft Position Report (msg. 9)	•	•
129802	1FB0A	AIS Safety Related Broadcast Message (msg. 14)	•	•
129809	1FB11	AIS Class B "CS" Static Data Report, Part A (msg. 24a)	•	•
129810	1FB12	AIS Class B "CS" Static Data Report, Part B (msg. 24b)	•	•
130074	1FC1A	WP List - WP Name & Position	•	
130306	1FD02	Wind Data	•	•
130310	1FD06	Environment (deprecated)		•
130311	1FD07	Environment (deprecated)		•
130312	1FD08	Temperature (deprecated)		•

PGN Decimal	PGN Hex	Description	TX	RX
130313	1FD09	Humidity	•	•
130314	1FD0A	Actual Pressure	•	•
130316	1FDOC	Temperature, extended range	•	•
130578	1FE12	Vessel Speed Components	•	•
131071	1FFFF	Simrad TV80 Data (ShipModul Proprietary)	•	•

Conversions from NMEA 2000 to NMEA 0183

PGN	Description	Type	Sentence	Freq.	Note
65286	Fluid Flow Rate (Maretron Proprietary)	I	YXXDR	2	
126992	System Time	D	ZDA	1	1
127237	Heading/Track Control	D	HDG, HDT or THS	10	
127245	Rudder	D	RSA	2	
127250	Vessel Heading	D	HDG, HDT or THS	10	
127251	Rate of Turn	D	ROT	10	
127252	Heave	I	YXXDR or PFEC,GPhve	10	
127257	Attitude	I	YXXDR or PFEC,GPatt	1	
127258	Magnetic variation	D	HDG, RMC	-	2
127488	Engine Parameters, Rapid Update	I	ERRPM, ERXDR	10	
127489	Engine Parameters, Dynamic	I	ERXDR	2	
127505	Fluid Level	I	YXXDR	0.4	
127508	Battery Status	I	ERXDR	0.67	
128259	Speed, Water referenced	D	VBW, VHW	10	
128267	Water Depth	D	DBT or DPT	1	
128275	Distance Log	D	VLW	1	
129025	Position, Rapid Update	D	GGA, GLL, RMC	1	3
129026	COG & SOG, Rapid Update	D	RMC, VTG	1	3
129029	GNSS Position Data	S D	GGA, GLL, RMC ZDA	1 1	3
129033	Local Time Offset (V1.300 Time and Date)	D	ZDA	1	1
129038	AIS Class A Position Report (msg. 1,2,3)	I	VDM, VDO	-	
129039	AIS Class B Position Report (msg. 18)	I	VDM, VDO	-	
129040	AIS Class B Extended Position Report (msg. 19)	I	VDM, VDO	-	
129041	AIS Aids to Navigation (AtoN) report (msg. 21)	I	VDM, VDO	-	
129283	Cross Track Error	D	APB, RMB, XTE	1	
129284	Navigation Data	D	APB, BWC/BWR, RMB, ZTG	1	4
129285	Navigation - Route/WP Information	D	APB, BWC/BWR, RMB, ZTG	1	4
129291	Set & Drift, Rapid Update	D	VDR	1	
129539	GNSS DOP's	D	GGA, GSA	1	
129540	GNSS Sats in view	I	GSA, GSV	-	
129793	AIS Base Station (msg. 4)	I	VDM, VDO	-	
129794	AIS Class A Static/Voyage Data (msg. 5)	I	VDM, VDO	-	
129798	AIS SAR Aircraft Position Report (msg. 9)	I	VDM, VDO	-	
129802	AIS Safety Related Broadcast Message (msg. 14)	I	VDM, VDO	-	
129809	AIS Class B Static Data report: Name (msg. 24a)	I	VDM, VDO	-	
129810	AIS Class B Static Data report: Static Data (msg. 24b)	I	VDM, VDO	-	
130306	Wind Data	D	MWD, [MDA] MWV	1 5	5
130310	Environment (deprecated)	D	MTW, XDR, [MDA]	1	5
130311	Environment (deprecated)	D	MTW, XDR, [MDA]	1	5
130312	Temperature (deprecated)	D	MTW, XDR, [MDA]	1	5
130313	Humidity	D	XDR, [MDA]	1	5
130314	Actual Pressure	D	XDR, [MDA]	1	5

PGN	Description	Type	Sentence	Freq.	Note
130316	Temperature, extended range	D	MTW, XDR, [MDA]	1	5
130578	Vessel Speed Components	D	VBW, VHW	10	
131071	Simrad TV80 Data (ShipModul Proprietary)	I	PSIMTV80	-	

Type:

- D: Conversion through database, no direct link between reception of PGN and transmission of sentence.
- I: Immediate conversion: PGN is converted to sentence and transmitted immediately. The indicated frequency of this sentence is equal to the frequency of the received PGN and is the default value as specified by NMEA 2000. The actual frequency depends on the implementation of the transmitting device.
- S: Conversion through database, transmission of sentence is synchronized with reception of PGN to minimize latency.

Notes:

- 1: ZDA must be specifically enabled on the Options tab.
- 2: The magnetic variation is stored only, it does not trigger transmission of HDG or RMC sentences.
- 3: The frequency of these sentences can be set to 10 Hz (except ZDA).
- 4: Either BWC or BWR is transmitted, depending on field 6 (Calculation Type: Great Circle or Rhumb Line) of PGN 129284. If the calculation type is unspecified, great circle (BWC) will be assumed.
- 5: MDA must be specifically enabled. High-resolution barometric pressure from PGN 130314 has precedence over low resolution barometric pressure of PGNs 130310 and 130311.

Conversions from NMEA 2000 to NMEA 0183 XDR sentences

Several NMEA 2000 PGNs are converted to NMEA 0183 XDR sentences using specific Transducer Types, Units and Transducer IDs, in accordance with NMEA 0183 V4.11. Whenever a PGN supports an Instance field and this Instance field contains a valid number, this number is appended to the Transducer ID.

A Transducer ID for the first/port engine would thus be "Engine#0", and the second/starboard engine would be "Engine#1"

Engine data

Engine data is converted to \$ERXDR sentences using Transducer Types, Units and ID's below:

PGN	Parameter	Type	Unit	ID
127488	Boost pressure	P	B (bar)	EngineBoost
127488	Engine tilt	A	P (%)	EngineTilt
127489	Engine oil pressure	P	B (bar)	EngineOil
127489	Engine oil temperature	C	C (°C)	EngineOil
127489	Engine temperature	C	C (°C)	Engine
127489	Alternator voltage	U	V (Volt)	Alternator
127489	Fuel rate	R	l (liter/second)	Fuel
127489	Engine hours	G	-	EngineHrs
127489	Engine coolant pressure	P	B (bar)	EngineCool
127489	Fuel pressure	P	B (bar)	Fuel
127489	Engine status	G	-	EngineSts
127489	Percent engine load	G	P (%)	EngineLoad
127489	Percent engine torque	G	P (%)	EngineTorq
127508	Battery voltage	U	V (Volt)	Battery
127508	Battery current	I	A (Ampere)	Battery
127508	Battery case temperature	C	C (°C)	Battery

Generic sensor data

Generic sensor data is converted to \$YXXDR sentences using Transducer Types, Units and ID's below:

PGN	Parameter	Type	Unit	ID
65286	Fluid Type	R	l (liter/second)	Fuel FreshWater WasteWater LiveWater Oil BlackWater Gasoline
127505	Fluid Level	E	P (%)	Fuel FreshWater WasteWater LiveWater Oil BlackWater Gasoline

Meteorological data

Meteorological data is converted to \$WIXDR sentences using Transducer Types, Units and ID's below:

PGN	Parameter	Type	Unit	ID
130310	Outside temperature	C	C (°C)	Air
130310	Atmospheric pressure	P	B (bar)	Baro
130311	Outside temperature	C	C (°C)	Air
130311	Outside humidity	H	P (%)	Air
130311	Atmospheric pressure	P	B (bar)	Baro
130312	Outside temperature	C	C (°C)	Air
130313	Outside humidity	H	P (%)	Air
130314	Atmospheric pressure	P	B (bar)	Baro
130316	Outside temperature	C	C (°C)	Air

Conversions from NMEA 0183 to NMEA 2000

Sentence	Description	Type	PGN	Freq.	Note
APB	Heading/Track controller (to autopilot)	D	129283	1	
			129284	1	
			129285	1	
DBT	Depth below transducer	D	128267	1	
DPT	Depth	D	128267	1	
GGA	GPS - latitude/longitude, fix data	D	126992	1	
			129025	10	
			129029	1	
			129539	1	
GLL	GPS - latitude/longitude	D	126992	1	
			129025	10	
			129029	1	
GSA	GNSS DOP & active satellites	D	129539	1	
			129540	1	
GSV	GNSS satellites in view	D	129540	1	
HDG	Heading ,Magnetic, deviation & variation	D	127250	10	
			127258	1	
HDM	Heading, Magnetic	D	127250	10	
HDT	Heading, True	D	127250	10	
MDA	Meteorological data	D	130313	0.5	
			130314	0.5	
			130316	0.5	
MTW	Water temperature	D	130316	0.5	
MWD	Wind direction & speed	D	130306	10	
MWV	Wind angle & speed	D	130306	10	1
PSIMTV80	Simrad TV80 Data (ShipModul Proprietary)	I	131071		4
RMB	Navigation Data (to autopilot)	D	129283	1	2
			129284	1	
			129285	1	
RMC	GPS - latitude/longitude, SOG, COG, variation	D	126992	1	3
			127250	-	
			127258	1	
			129025	10	
			129026	4	
		S	129029	1	
ROT	Rate of turn	D	127251	10	
RSA	Rudder sensor angle	D	127245	10	
THS	Heading, True	D	127250	10	
VBW	Dual ground/water speed	D	128259	1	
			130578	4	
VDM/VDO	AIS	I	129038	-	
			129039	-	
			129040	-	
			192041	-	
			129793	-	
			129794	-	
			129798	-	
			129802	-	
			129809	-	
			129810	-	
VDR	Set & drift	D	129291	1	
VHW	Water speed & heading	D	127250	10	
			128259	1	
			130578	4	
VLW	Dual ground/water distance	D	128275	1	

Sentence	Description	Type	PGN	Freq.	Note
VTG	Course over ground & ground speed	D	129026	4	
VWR	Apparent wind angle & speed	D	130306	10	
VWT	Theoretical/true wind angle & speed	D	130306	10	
WPL	Waypoint location	I	130074	-	
XDR	Mast Angle	D	65330	2	4
XDR	Air temperature, humidity and barometric pressure	D	130310 130314 130315	0.5 0.5 0.5	5
XTE	Cross track error (to autopilot)	D	129283	1	
ZDA	Time & date	D	126992	1	6
ZTG	UTC & time to destination waypoint	D	129284	1	

Type:

- D: Conversion through database, no direct link between reception of sentence and transmission of PGN.
- I: Immediate conversion: Sentence is converted to PGN and transmitted immediately.
- S: Conversion through database, transmission of PGN is synchronized with reception of sentence to minimize latency.

Notes:

- 1: When true wind is converted, the MiniPlex-3PRO will transmit this PGN twice: with Wind Reference 3 (calculated referenced to ground) and Wind Reference 4 (calculated referenced to water) to ensure compatibility with all receivers.
- 2: Field 6 (Calculation Type) of PGN 129284 will be set to Great Circle.
- 3: The magnetic variation is extracted from the RMC sentence, but this does not trigger transmission of PGN 127250. This PGN will only be transmitted on reception of a heading sentence. The stored magnetic variation will then be placed in PGN 127250.
- 4: This is a proprietary PGN.
- 5: The Talker ID must be "WI". Decoded types, units and IDs are respectively: C, C, TEMP; P, B, PRESS and H, P, RH.
- 6: PGN 126992 must be specifically enabled on the Options tab.

Converted SeaTalk Datagrams

Datagram	Description	TX	RX	Note
00	Depth below transducer	•	•	
01	Equipment ID	•	•	1
10	Wind angle	•	•	
11	Wind speed	•	•	
20	Speed through water, 1/10 kn	•	•	2
21	Trip mileage	•	•	3
22	Total mileage	•	•	3
23	Water temperature, °C + °F	•	•	4
25	Total and Trip mileage	•	•	3
26	Speed through water, 1/100 kn	•	•	2
27	Water temperature 1/10 °C	•	•	4
30	Set lamp intensity	•	•	1
50	Latitude	•	•	5
51	Longitude	•	•	5
52	Speed over ground	•	•	
53	Course over ground	•	•	
54	Time	•	•	
56	Date	•	•	
57	GPS Satellites & HDOP		•	
58	Latitude and longitude	•	•	5
80	Set lamp intensity	•	•	1
81	Course computer message	•	•	1
82	Short waypoint name	•	•	6
83	Course computer message	•	•	1
84	Autopilot heading and rudder position		•	
85	Navigation data	•	•	
86	Keystroke (incl. S100 remote control)	•	•	1
87	Set response level	•	•	1
88	Autopilot parameters	•	•	1
89	Heading	•	•	
90	Equipment ID	•	•	1
91	Set rudder gain	•	•	1
92	Set autopilot parameter	•	•	1
93	Enter autopilot setup	•	•	1
95	Autopilot setup output	•	•	1
99	Magnetic variation	•	•	
9A	Version string	•	•	1
9C	Compass heading and rudder position		•	
A1	Long waypoint name	•	•	6
A2	Arrival status	•	•	
A3	Rudder angle	•	•	
A4	Device query broadcast/device ID	•	•	1
A5	GPS info and status	•	•	

Notes:

- 1: These datagrams are converted from/to Raymarine proprietary PGN 126720 if In1 is set to **SeaTalk-STNG** mode.
- 2: Datagram 20 is ignored if datagram 26 is received.
- 3: Datagrams 21 and 22 are ignored if datagram 25 is received.
- 4: Datagram 23 is ignored if datagram 27 is received.
- 5: Datagrams 50 and 51 are ignored if datagram 58 is received.
- 6: Datagram 82 is ignored if datagram A1 is received.

When option **Raw SeaTalk** is enabled, unlisted datagrams are converted into a proprietary NMEA sentence with the following format:

```
$PSMDST,R,aa,bb,cc...*hh<CR><LF>
```

aa,bb,cc... represent the hexadecimal value of the bytes from the received SeaTalk datagram.

Firmware Update Error messages

During a firmware update, the following warnings or error messages may be displayed:

The firmware update failed

This message appears when the overall update process failed without any other error message. It is shown when the updated multiplexer firmware does not report a version message after start-up.

Not a valid firmware file

The file you are trying to open is not a valid firmware file. A firmware file not only ends with an ".mpx" extension, it also contains a distinct signature that must be present. This prevents you from accidentally loading the wrong file into the multiplexer.

Unsupported firmware file version

The firmware file version is not supported by MPXConfig3Pro

Firmware file is corrupt

The firmware file is damaged, possible due to an error during download from our website.

The version of the firmware file is lower than the version of the multiplexer. Do you really want to proceed?

You are trying to update the firmware in the multiplexer with an older version. This is just a warning and very well possible to do.

Bootloader initialisation failed

When MPXConfig3Pro starts the update process, a small program called the Bootloader must be started in the multiplexer. This message tells you that the bootloader could not be started. This can happen when you try to update the multiplexer while navigation instruments are connected and sending lots of NMEA data to the multiplexer. This can interfere with starting the update process. Disconnect or power down the instruments to prevent this problem.

Firmware file does not match with the multiplexer type

Most firmware files will be compatible with all types of multiplexers. It is however possible that special firmware is made available which only runs on a specific type of multiplexer. If this message appears, you apparently are trying to update using a firmware file that is not suitable for your type of multiplexer.

Bootloader: Erase command timeout

An error occurred when the bootloader tried to erase the old firmware.

Bootloader: Encryption command timeout

The bootloader did not respond to the Encryption command sent by MPXConfig3Pro.

Bootloader: Programming timeout

There was an error during programming a section of the firmware image.

Bootloader: CRC command timeout

The bootloader failed to calculate the checksum of the newly loaded firmware image.

Bootloader: CRC error

The calculated checksum of the newly loader firmware image does not match the checksum if the image file. Apparently, there was a communication error between MPXConfig3Pro and the multiplexer. You can try to update again.

Invalid response from bootloader

The bootloader returned an unknown response to a command from MPXConfig3Pro.

Supported Configuration and Status Sentences

Introduction

The MiniPlex-3PRO is configured using proprietary NMEA 0183 sentences received through its host interface. These will be called commands. These commands always result in a response from the MiniPlex-3PRO. All commands and responses begin with \$PSMD and have the following format:

\$PSMDxxx, a, b, c, ...*hh<CR><LF>

\$P: Start of a proprietary sentence as dictated by the NMEA standard

SMD: ShipModul manufacturer mnemonic

xxx: Proprietary sentence formatter

a: Sentence Status flag:

C = sentence is a command to change settings

R = sentence is a status report of current settings

b,c,...: Optional fields

*hh: Optional checksum field

<CR><LF>: Carriage Return (0x0D, \r) and Line Feed (0x0A, \n) characters that terminate the sentence

Unless specified otherwise, fields are optional and may be skipped if no change is required. For instance, a \$PSMDCF, C, , 2 command only changes the priority time-out. The preceding field is skipped. Any trailing field may be omitted. Some commands require multiple or even all fields to be present because they are related to each other like in the \$PSMDRTE command, which defines a route for an NMEA sentence.

Configuration commands and status reports

Sentences used to both set and retrieve a configuration setting have a Sentence Status field. This field is the first field of the sentence and can be one of the following:

C: the sentence is a configuration command to change settings

R: the sentence is a status report of current settings

A configuration command (C) is sent to the MiniPlex-3PRO to change a setting. A status report (R) is sent by the MiniPlex-3PRO to report a setting.

When the MiniPlex-3PRO receives a configuration command, it will always respond with a status report sentence with the new settings. Exceptions are commands which transfer tables, like routing or modbus tables. A command to retrieve a table from the MiniPlex-3PRO results in a series of table definitions, followed by a \$PSMDRDY sentence.

When a table is transferred to the MiniPlex-3PRO, a 200ms timer guards this upload. Each time the MiniPlex-3PRO receives a table command, the timer is restarted. When no more sentences are received, the timer expires, the MiniPlex-3PRO will program the received table in non-volatile memory and respond with a \$PSMDRDY sentence.

Unless specified otherwise, all command sentences return a response with their settings when the command is received without parameters. Commands which transfer tables, will transmit the contents of the table when received without parameters.

A sentence with its Sentence Status field set to 'R' is ignored by the MiniPlex-3PRO.

Example

The \$PSMDID sentence controls the Talker ID settings of the MiniPlex-3PRO. When \$PSMDID is sent to the MiniPlex-3PRO, it will report with the current Talker ID settings with:

\$PSMDID,R,aa,bb,cc,dd,ee,ff,gg,hh,ii*hh

To set the change the Talker ID settings, send the following sentence:

\$PSMDID,C,aa,bb,cc,dd,ee,ff,gg,hh,ii*hh

The MiniPlex-3PRO will then respond with:

\$PSMDID,R,aa,bb,cc,dd,ee,ff,gg,hh,ii*hh

This response will contain the new Talker ID's.

Standard NMEA 0183 Sentences

\$MXPGN – NMEA 2000 PGN Data

This sentence transports NMEA 2000/CAN frames in NMEA 0183 format. The MiniPlex-3PRO will output this sentence with Talker ID "MX". When sent to the MiniPlex-3PRO, the Talker ID is ignored unless a routing entry exists for this sentence.

Format: \$--PGN,pppppp,aaaa,c--c*hh<CR><LF>

pppppp: PGN of the NMEA 2000/CAN frame, 3-byte hexadecimal number. If the PGN is non-global, the lowest byte contains the destination address.

aaaa: Attribute Word, 2-byte hexadecimal number. This word contains the priority, the DLC code and then source/destination address of the frame, formatted as shown below:

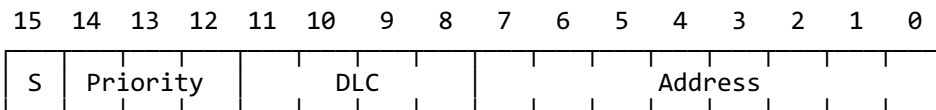

S: Send bit. When an NMEA 2000/CAN frame is received, this bit is 0. To use the \$MXPGN sentence to send an NMEA 2000/CAN frame, this bit must be set to 1.

Priority: Frame priority. A value between 0 and 7, a lower value means higher priority.

DLC: Data Length Code field, contains the size of the frame in bytes (1..8) or a Class 2 Transmission ID (9..15).

Address: Depending on the Send bit, this field contains the Source Address (S=0) or the Destination Address (S=1) of the frame.

c--c: Data field of the NMEA 2000/CAN frame, organized as one large number in hexadecimal notation from MSB to LSB. This is in accordance with "NMEA 2000 Appendix D", chapter D.1, "Data Placement within the CAN Frame".

The size of this field depends on the DLC value and can be 1 to 8 bytes (2 to 16 hexadecimal characters).

NMEA 2000 Reception

When the MiniPlex-3PRO converts an NMEA 2000/CAN frame into an \$MXPGN sentence, the S bit in the Attribute field will be 0 and the Address field contains the source address of the frame. The destination address of the frame is either global or contained in the lower byte of the PGN, in accordance with the NMEA 2000/ISO specification.

NMEA 2000 Transmission

A \$--PGN sentence sent to the MiniPlex-3PRO will be converted to an NMEA 2000/CAN frame if the S bit in the Attribute field is 1.

The Address field is the Destination Address of the NMEA 2000/CAN frame. The Source Address of the frame will be the address the MiniPlex-3PRO has acquired during the Address Claim Procedure. If a global PGN is used, the contents of the Address field will be ignored. A non-global PGN can be sent globally by setting the Address field to 0xFF.

The Destination Address of a non-global PGN can also be specified by loading it into the lower byte of the PGN. The Address field of the Attribute word must be set to 0x00 for this.

The DLC field must be set to the size of the Data field (1 to 8 bytes) and the actual size of the Data field must match with the DLC. If the DLC field is used as a Class 2 Transmission ID (9..15), the size of the Data field must be 8 bytes/16 characters. If any of these conditions is not met, the frame will not be transmitted.

For quick transmission of an NMEA 2000/CAN frame, the Attribute field of the \$--PGN sentence may be omitted. In this case, the following values for the Attribute will be assumed:

- S: 1
- Priority: 7
- DLC: Set automatically from the size of the Data field (c--c) field.
- Address: 0. The Destination Address of the message will be contained in the PGN field (pppppp).

Examples

A received PGN 127250 (hex: 1F112, Vessel Heading) will be converted into the following \$MXPNG sentence:

```
$MXPNG,01F112,2807,FC7FFF7FFF168012*11
```

The Attribute word shows a received frame (S=0), with priority 2, it is 8 bytes and the Source Address is 0x07.

To transmit PGN127250, the following \$--PGN sentence must be sent to the MiniPlex-3PRO:

```
$MXPNG,01F112,A800,FC7FFF7FFF168012*65
```

In this example, the Address field of the Attribute field is ignored and set to 0x00 because PGN 127250 is a Global PGN.

An ISO Request (PGN 059904) can be transmitted in the following ways:

```
$MXPNG,00EA00,F309,01F016*68
```

```
$MXPNG,00EA09,,01F016*1D
```

In both cases, this message is sent to Destination Address 0x09. In the first sentence, the Destination Address is specified in the Attribute word, the second sentence has it embedded in the PGN field.

\$--XDR – Sensor Data

The data received from certain NMEA 2000 sensors or Modbus slaves will be converted into standard NMEA 0183 \$--XDR sentences. The Talker ID of this sentence depends on the source of the data. For instance: "ER" for engine related data, "WI" for weather data and "YX" for generic sensor data.

Format: \$MXXDR,t,x.x,u,i[,t,x.x,u,i][,t,x.x,u,i][...]

t: Transducer Type

x.x: Sensor value

u: Units

i: Transducer ID

For engine sensor and weather data, the contents of **t**, **u** and **i** fields are compliant with NMEA 0183 V4.11. For sensor data received from Modbus slaves, the **t**, **u** and **i** fields contain the parameters specified in the Modbus table.

Multiple groups of **t,x,u,i** parameters are collated into one XDR sentence as long as the sentence length permits. The exact number of **t,x,u,i** groups depends on the length of the value and Transducer ID and may vary.

TAG Blocks

When TAG blocks are enabled, the MiniPlex-3PRO prepends each NMEA sentence transmitted on the host interface with a TAG Block. This TAG block has a source parameter containing the UI (Unique Identifier) of the MiniPlex-3PRO and the input number or Source Address of the received sentence.

This TAG block It has the following format:

```
\s:UI-x*hh\
```

or

```
\s:UI#xx*hh\
```

UI is the Unique Identifier of the MiniPlex-3PRO. The separator character ('-' or '#') indicates whether the TAG Block identifies an NMEA 0183 input ('-') or an NMEA 2000 Source Address ('#') as a hexadecimal number.

If an NMEA 0183 input is identified, x can have the following values:

- 0: Internally generated responses (\$PSMD sentences)
- 1: NMEA 0183 In1/SeaTalk
- 2: NMEA 0183 In2
- 3: NMEA 0183 In3
- 4: NMEA 0183 In4
- 5: NMEA 0183 In5
- 6: NMEA 0183 In6
- 7: NMEA 0183 In7
- 8: NMEA 0183 In8
- 9: Conversion results

If no UI is specified with the \$PSMDUI sentence, "MXnn" is used, where "nn" are the last two digits of the serial number of the MiniPlex-3PRO.

A heading sentence received on input 1 will thus be transmitted as

```
\s:MX01-1*1E\$\$HEHDT,23.5*37<CR><LF>
```

A similar sentence generated from an NMEA 2000 source will be transmitted as

```
\s:MX01#4D*A2\$\$HEHDT,23.5*37<CR><LF>
```

Proprietary NMEA 0183 Sentences - General

\$PSMDCF – Set Configuration

This sentence sets various configuration settings of the MiniPlex-3PRO.

Format: \$PSMDCF,a,b,t*hh<CR><LF>

a: Sentence Status flag:

C = sentence is a command to change settings

R = sentence is a status report of current settings

A = sentence is a flag indicating MPX-Config3 is connected*)

b: Baud rate selector for the RS-232 interface (ignored when no RS-232 port present):

0 = 4800 Baud

1 = 9600 Baud

2 = 19200 Baud

3 = 38400 Baud

4 = 57600 Baud

5 = 115200 Baud

t: Priority Timeout (in seconds):

0 = 1

1 = 2

2 = 3

3 = 5

4 = 10

5 = 30

The 's' field will always return a 0 or 1 in response to a CF query sentence.

*) When MPX-Config3 is connected, it sends a \$PSMDCF,A sentence to the MiniPlex every 4 seconds. This temporarily enables TAG blocks to tell MPXConfig3Pro from which NMEA 0183 input or NMEA 2000 Source Address an NMEA sentence is received/generated.

\$PSMDCFQ – Get Configuration

This sentence requests the configuration of the MiniPlex-3PRO. The MiniPlex-3PRO will respond with all known configuration sentences, followed by a \$PSMDRDY sentence.

\$PSMDCNV – Set Conversions

This sentence enables or disables NMEA conversions.

Format: \$PSMDCNV,a,c,e*hh<CR><LF> (command only)

Or: \$PSMDCNV,a,xxxxxxxx*hh<CR><LF> (command and report)

a: Sentence Status flag:

C = sentence is a command to change settings

R = sentence is a status report of current settings

c: Conversion number

e: 0 = off/disable

1 = on/enable

xxxxxxxx: Enable/disable multiple conversions at once using a 32-bit hexadecimal number. Each bit represents a conversion where bit 0 is conversion 0, bit 1 is conversion 1, etc.

Example: \$PSMDCNV,C,6,1<CR><LF> (enables conversion 6)

\$PSMDCNV,C,0000021<CR><LF> (enables conversions 5 and 0)

The following conversions are implemented:

0: Heading Conversion Magnetic/True

Convert HDM and HDG sentences (magnetic heading) into HDT sentences (true heading). The heading is corrected from magnetic to true if a magnetic variation is available in the originating HDG sentence or from another source (RMC sentence, SeaTalk Datagram 99, PGN 127250 or 127258). The conversion also works in reverse: HDT sentences are converted into HDM sentences. No variation correction is performed in this case, the heading is simply copied.

1: Reverse Heading

Convert a heading sentence (HDG, HDM or HDT) into a sentence with the heading reversed by 180 degrees.

2: Enable COG to HDT Conversion

Convert VTG sentences (course over ground) into HDT sentences (true heading).

3: Wind Conversion VWR/MWV

Convert VWR sentences (relative wind, deprecated) into MWV,R sentences (relative wind) Convert MWV sentences into either VWR or VWT sentences, depending on the R or T flag in de MWV sentence.

4: Theoretical Wind Conversion – AWA/AWS to TWA/TWS

Convert MWV,R sentences (relative or apparent wind) into MWV,T sentences (theoretical wind). The required STW for this calculation is taken from any source of water speed. This conversion can be used in conjunction with conversion 3, to first convert VWR to MWV,R and then to MWV,T.

5: Calculate wind direction TWD

Convert a theoretical/true wind angle sentence (MWV,T) into true wind direction sentence (MWD).

6: Reverse wind angle

Converts a wind sentence (VWR, MWV) into a new MWV sentence with a reversed wind angle.

7: Velocity Conversion - VTG to VHW

Convert VTG sentences (GPS) into VHW sentences (speed log). This is the reverse of conversion 8.

8: Velocity Conversion – VHW to VTG

Convert VHW sentences (speed log) into VTG sentences (GPS). This is the reverse of conversion 7.

9: Reverse Speed

Convert VBW sentences into new VBW sentences with all speed values reversed.

10: Convert VBW or VHW to VHW with heading

Convert a VBW or VHW sentence into a new VHW sentence with its heading fields filled from any heading source.

11: Heading conversion HDT ↔ THS

This option converts an HDT sentence into a THS sentence and vice versa. The Talker ID in HDT and THS sentences is preserved to ensure compatibility with GPS compasses, which generally output a Talker ID "GP".

\$PSMDDR – Set Default Route

This sentence specifies the default route from the NMEA 0183 inputs or the NMEA 2000 network to the NMEA outputs and from the host interface(s) to the NMEA 0183 outputs. Any route set by the \$PSMDRTE sentence overrides the default route.

Format: \$PSMDDR, a, vvvv, b, www, c, xxxx, d, yyyy, e*hh<CR><LF>

a: Sentence Status flag:

- C = sentence is a command to change settings
- R = sentence is a status report of current settings

vvvv: Input field for NMEA Out1. This is a hexadecimal number where each bit represents an NMEA input. The following bits are defined:

- 0: NMEA In1
- 1: NMEA In2
- 2: NMEA In3
- 3: NMEA In4
- 4: NMEA In5
- 5: NMEA In6
- 6: NMEA In7
- 7: NMEA In8
- 8: NMEA Conversions
- 15: NMEA 2000

When a bit is 1, the input is routed to output 1, otherwise the input is not routed.

b: Host data to NMEA Out1:

- 0: Host data is not routed
- 1: Host data is routed
- 2: Host data is routed and overrides data from the inputs. A time out mechanism will route data from the inputs when no data from the host is received.

www: Input field for NMEA Out2, similar to field vvvv.

c: Host data to NMEA Out2, similar to field b.

xxxx: Input field for NMEA Out3, similar to field vvvv.

c: Host data to NMEA Out3, similar to field b.

yyyy: Input field for NMEA Out4, similar to field vvvv.

d: Host data to NMEA Out4, similar to field b.

\$PSMDID – Set Talker ID

This sentence sets a Talker ID for a specific input. If a Talker ID is specified, the original Talker ID of the sentences received on that input is replaced by the specified one, before sending the sentence to the host.

Format: \$PSMDID, a, aa, bb, cc, dd, ee, ff, gg, hh, ii*hh<CR><LF>

a: Sentence Status flag:

- C = sentence is a command to change settings
- R = sentence is a status report of current settings

aa: Talker ID for In1

bb: Talker ID for In2

cc: Talker ID for In3

dd: Talker ID for In4

ee: Talker ID for In5

ff: Talker ID for In6

gg: Talker ID for In7

hh: Talker ID for In8

ii: Talker ID for conversion results

hh: optional checksum

An empty field clears the Talker ID for that input

\$PSMDIN – Input modes

Set the operating mode of each NMEA input.

Format: \$PSMDIN,a,x,x,x,x,x,x,x,x*hh<CR><LF>

a: Sentence Status flag:

- C = sentence is a command to change settings
- R = sentence is a status report of current settings

x: Operating mode field for input 1 to 8:

- 0: Normal NMEA processing. This is the default processing mode in which sentences are checked for correct formatting according to the NMEA 0183 standard. Any sentence that is incorrectly formatted or has a checksum error is rejected. This behaviour meets the IEC/EN60945 requirements.
- 1: Forward NMEA sentences with a checksum error unmodified, bypassing all further NMEA processing, routing and conversions. Only the default route is applied. This allows other devices or software to detect the checksum error.
- 2: Relaxed NMEA format checking. This mode will accept incorrectly terminated sentences. Using this mode, a sentence is considered terminated if it ends on a *CR*, a *LF* or a combination of both in arbitrary order. A sentence with a checksum error is blocked. The multiplexer will terminate the forwarded sentence correctly with a *CR/LF* pair.
- 3: Receive plain text strings and forward them as \$MXTXT sentences. Any character with an ASCII value greater than 32 (a space) is regarded as the start of a string. The string must end on a *CR* or *LF* and its length may not exceed 61 characters. A longer string will result in a new \$MXTXT sentence containing the remainder of the string. Only valid NMEA characters are read. Invalid characters are stripped from the received string. The Total number and Sentence number fields of the \$MXTXT sentence are always set to "01". The Text Identifier field of the \$MXTXT sentence contains the input number on which the string was received. When for instance "Hello World" is received on input 3, the resulting sentence will be: \$MXTXT,01,01,03,Hello World*6E.
- 4: Receive plain text strings and forward them in \$PTXT sentences. Any character with an ASCII value greater than 32 (a space) is regarded as the start of a string. The string must end on a *CR* or *LF* and its length may not exceed 71 characters. A longer string will result in a new \$PTXT sentence containing the remainder of the string. The MiniPlex-3PRO will always terminate a forwarded string with a *CR/LF* pair. All characters with an ASCII value from 32 to 127 are forwarded.
- 5: Receive plain text strings and forward them unmodified. Any character with an ASCII value greater than 32 (a space) is regarded as the start of a string. The string must end on a *CR* or *LF* and its length may not exceed 77 characters. A longer string will result in a new string containing the remainder of the original string. The MiniPlex-3PRO will always terminate a forwarded string with a *CR/LF* pair. All characters between from ASCII 32 to 127 are forwarded.
- 6: Available on In1 only. This mode switches In1 to SeaTalk mode and fixes its speed to 4800 Baud. When this mode is selected, In1 becomes a fully bi-directional SeaTalk port which can receive and transmit SeaTalk data. See page 62 for an overview of the converted SeaTalk datagrams.

When this mode is selected, the \$PSMDOP response will show option 1 enabled. Any other mode (0..5) will clear both SeaTalk option bits in the \$PSMDOP response.

- 7: Available on In1 only. This mode switches In1 to SeaTalk mode with RayMarine SeaTalk-STNG converter emulation and fixes its speed to 4800 Baud. When this mode is selected, In1 becomes a fully bi-directional SeaTalk port which can receive and transmit SeaTalk data. Conversions of SeaTalk control datagrams is also supported, like Raymarines own SeaTalk-STNG converter. This allows for instance a SeaTalk remote control to be used to control a SeaTalk^{NG} autopilot. This mode should not be used when a RayMarine SeaTalk-STNG converter is already present on the SeaTalk^{NG}/NMEA 2000 network, because this would result in a data-loop, flooding the SeaTalk bus with control messages. See page 62 for an overview of the converted SeaTalk datagrams.

When this mode is selected, the \$PSMDOP response will show option 1 enabled. Any other mode (0..5) will clear both SeaTalk option bits in the \$PSMDOP response.

\$PSMDLDR – Loader message

This sentence is transmitted by the bootloader through the host interface. It contains the loader version and multiplexer ID. The loader will wait for a special key during 0.2s after sending this sentence. When no key is received, the application code is started. If no application code is found, the loader will transmit this sentence continuously.

Format: `$PSMDLDR,xx,v.v,zzz,rr`

xx: Hardware ID of the multiplexer (a hexadecimal number)
v.v: Bootloader version number
zzz: Hardware name of the multiplexer
rr: Reset source

The following hardware ID's and names are defined:

11: MPX-3U board with USB interface
12: MPX-3E board with Ethernet interface
13: MPX-3UW board with USB and WiFi interface
94: MPX-3PRO MiniPlex-3PRO board

Bit 7 of the hardware ID indicates the presence of an NMEA 2000 interface.

This sentence has no checksum.

The Reset source indicates what caused the multiplexer to restart or reset. It is a hexadecimal bit-field with the following bits defined:

- 0: Power-on reset (01)
- 1: External reset via Reset pin (02)
- 2: Brownout reset (04)
- 3: Watchdog reset (08)
- 4: Program and Debug interface reset (10)
- 5: Software reset (20)

The value in brackets indicate the value of the reset source field when the corresponding bit is set. A few values are of interest when troubleshooting a multiplexer which transmits \$PSMDLDR sentences continuously:

Power-on reset (01): A bad power connection (loose contact), causing the multiplexer to restart.

Brownout reset (04): This reset occurs when the supply voltage is too low. When the multiplexer is powered from a pulsing DC source (e.g. a battery charger at home), it will almost continuously transmit \$PSMDLDR sentences ending on 04. This is because a battery charger does not provide a smooth DC voltage but a pulsating (100 or 120Hz) DC voltage, causing the multiplexer to reset continuously.

Watchdog reset (08): This reset indicates a watchdog time out. The watchdog timer is a safety measure using a timer which must be reset periodically by the running firmware. When this no longer happens because the firmware is "stuck" somewhere or not loaded, the watchdog timer eventually will time out and reset the multiplexer. A continuous stream of \$PSMDLDR sentences with this reset value is transmitted when a firmware update failed.

Software reset (20): This value can be seen when issuing a \$PSMDRESET command, which effectively results in a software reset.

Example: `$PSMDLDR,91,2.2,MPX-3U,01`

This multiplexer has an MPX-U board with a USB interface and has an NMEA 2000 interface; the bootloader is version 1.2; the reset source was a power-on event.

\$PSMDB – Modbus

This sentence sets various Modbus-master related parameters. The format of the \$PSMDB sentence depends on the character in the first and second field of the sentence and whether it is a command or a report:

\$PSMDB,C,X	Command to add a slave/register definition to be transmitted as XDR sentence.
\$PSMDB,C,DELETE	Command to delete all slave/register definitions. The multiplexer will respond with a \$PSMDRDY sentence.
\$PSMDB,C,R	Command to set the rate of the transmitted XDR sentences in 10ms increments. The default value is 100, transmitting XDR sentences every 1000ms.
\$PSMDB,D	Raw Modbus frame data report.
\$PSMDB,E	Error report.
\$PSMDB,R,X	Slave/register definition report.

The Modbus Master function is enabled with Option 7.

Two options are dedicated to Modbus:

- 7: Enable/disable Modbus
- 8: Enable/disable Modbus Error reports (PSMDB, E, ... sentence)

When Modbus is enabled, NMEA Out2 becomes a Modbus RTU (RS485) port. Its baud rate is still controlled by the speed setting of NMEA Out2 on the **NMEA Inputs & Outputs** tab of MPXConfig3Pro. All routing of NMEA 0183 data to Out2 is inhibited when Modbus is enabled. The communication parameters are fixed to 8 data bits, 2 stop bits and no parity. Only the communication speed can be changed.

\$PSMDB,C,X – Define Modbus Slave/Register

This sentence adds an entry into the Modbus table, defining a Modbus slave/register pair as well as the data format and the contents of the generated NMDA 0183 XDR sentences.

Format: \$PSMDB,a,X,s,r,t,d,r,p,t,u,i*hh<CR><LF>

a:	Sentence Status flag: C = sentence is a command to change settings R = sentence is a status report of current settings
s:	Modbus slave address, 1..247
r:	Modbus register number, 0..65535 (0-based protocol address)
t:	Modbus register type: H: Holding register (function code 03) I: Input register (function code 04)
d:	Data type: I: Signed integer (16-bit/1 register) U: Unsigned integer (16-bit/1 register) L: Signed long integer (32-bit/2 registers) F: Floating point (32-bit/2 registers)
r:	Optional 'R' to reverse the Modbus register order in case of a multi-register read operation (Data types "L" and "F"). Can be left empty if not required.
p:	Precision or number of decimals for value in Modbus register (0 to 7)
t:	Transducer Type in the XDR sentence, one character
u:	Units in the XDR sentence, one character
i:	Transducer ID in the XDR sentence, 15 characters max.

Modbus,C,DELETE – Delete Table

The following sentence deletes all Modbus slave/register entries:

\$PSMDB,C,DELETE*hh<CR><LF>

The multiplexer will respond with a \$PSMDRDY sentence. This also indicates the start of a time window of 200ms during which new \$PSMDB,C,X,... sentences are accepted to set new slave/register entries. Each received \$PSMDB,C,X,... sentence restarts this window. When the last \$PSMDB,C,X,... sentence is received, the window will eventually time out and the multiplexer will store the received slave/register

definitions in non-volatile memory. When the slave/register definitions are stored, the multiplexer will respond again with a \$PSMDRDY sentence.

The multiplexer will ignore any further \$PSMDB, C, X, ... sentences when the window has timed out or when then maximum number of 30 entries is reached.

\$PSMDB

This sentence returns all entries in the Modbus table. The returned sentences have the same format as the \$PSMDB, C, X, ... command, with an additional slave-status field at the end. The Sentence Status flag field contains an 'R', indicating this is a response. A \$PSMDRDY sentence marks the end of the list.

Example:

```
$PSMDB, R, X, 1, 1, H, I, , 2, C, C, Temp, 00*10<CR><LF>  
$PSMDB, R, X, 1, 0, H, I, , 2, P, P, Hum, 00*6D<CR><LF>  
$PSMDRDY, R*45<CR><LF>
```

The sentences may not be transmitted as one contiguous block. In case of much NMEA data, they may be interspersed with other NMEA sentences.

The status field can have the following values:

- 00: Communication is succesful.
- 01-0B: Modbus Exception Code. This is an error code returned by the Modbus slave. These are defined in "Modbus Application Protocol V1.1" which can be downloaded from www.modbus.org.
- F0: No status known yet
- FA: The slave response contains the wrong register count.
- FB: The received response originates from the wrong slave.
- FC: Communication error (parity, framing or overrun).
- FD: The slave response has an incorrect frame size.
- FE: The slave response has an incorrect CRC.
- FF: No response received/slave timed out.

\$PSMDB, C, R

This sentence sets the rate or interval between the transmitted XDR sentences.

Format: \$PSMDB, C, R, x*hh<CR><LF>

x: Interval time in 10 ms increments. Valid range is 1 to 65535.

A value of 100 sets an interval time of 100 x 10 = 1000 ms or 1 second.

\$PSMDB, D

Raw Modbus frame data. This sentence is transmitted when error reports are enabled with Option 8. This can be used to diagnose a communication problem or to detect a faulty Modbus slave.

Format: \$PSMDB, D, x, h--h*hh<CR><LF>

x: Direction indicator:
T: Transmitted frame
R: Received frame

h--h: Raw Modbus frame data

The frame data contains every single byte of a Modbus frame, including the 2-byte CRC at the end.

Example:

```
$PSMDB, D, T, 010300000001840A*47<CR><LF>  
$PSMDB, D, R, 010302000B844*45<CR><LF>
```

These two sentences show one transmitted request to and a received response from slave 1 with function code 3.

\$PSMDMB,E

Modbus Error report. This sentence is transmitted when error reports are enabled with Option 8.

Format: \$PSMDMB,E,a,r,s,c*hh<CR><LF>

a: Slave address

r: Register number

s: Status code or Modbus exception code:

01-0B: Modbus Exception Code.

F0: No status known yet

FA: The slave response contains the wrong register count.

FB: The received response originates from the wrong slave.

FC: Communication error (parity, framing or overrun).

FD: The slave response has an incorrect frame size.

FE: The slave response has an incorrect CRC.

FF: No response received/slave timed out.

c: Calculated CRC.

If the received response message is shorter than 5 bytes, the CRC field is empty.

The Modbus Exception Codes are defined in "Modbus Application Protocol V1.1" which can be downloaded www.modbus.org.

This sentence is transmitted only if an error or exception occurs and always prior to the \$PSMDMB,D,R sentence.

Example:

```
$PSMDMB,D,T,010300000001840A*47<CR><LF>
```

```
$PSMDMB,E,1,0,FE,44B8*14<CR><LF>
```

```
$PSMDMB,D,R,0103020000D48D*33<CR><LF>
```

This example shows a CRC error (code FE). The received frame has a CRC of 8DD4 (last two bytes placed in correct order) while the \$PSMDMB,E sentence shows a calculated CRC of 44B8.

\$PSMDOP – Set Options

This sentence enables or disables options which control the operation of the multiplexer.

Format: \$PSMDOP,a,o,e*hh<CR><LF> *(command only)*

or: \$PSMDOP,a,xxxxxxxx*hh<CR><LF> *(command and report)*

a: Sentence Status flag:

C = sentence is a command to change settings

R = sentence is a status report of current settings

o: option number

e: 0 = off/disable

1 = on/enable

xxxxxxxx: Enable/disable multiple options at once using a 32-bit hexadecimal number. Each bit represents an option where bit 0 is option 0, bit 1 is option 1, etc.

Example: \$PSMDOP,C,6,1<CR><LF> *(enables option 6)*

\$PSMDOP,C,00000021<CR><LF> *(enables options 5 and 0)*

The following options are implemented:

0: Routing Block

Block sentences which are not found in the routing table. The default operation is to apply the default route to those sentences.

1: SeaTalk to NMEA Conversion

SeaTalk data is converted to NMEA 0183 sentences and to NMEA 2000 PGN's (-N2K models only). This option will also be reflected in the \$PSMDIN response: input 1 will report **SeaTalk** mode.

2: SeaTalk to \$PSMDST Conversion

SeaTalk datagrams are converted into \$PSMDST sentences, which contain the "raw" bytes of a SeaTalk datagram as hexadecimal numbers.

If option 1 is enabled, only those datagrams are converted which could not be converted into NMEA 0183 and/or NMEA 2000.

If option 1 is disabled, all datagrams are converted into \$PSMDST sentences. This option will also be reflected in the \$PSMDIN response: input 1 will report SeaTalk mode.

3: Test GPS Status Field

If this option is enabled, a GPS related NMEA 0183 sentence will be discarded if its status field indicates invalid data ('V'). This forces the Priority mechanism to pass GPS sentences from a lower priority source with a valid status. This option also blocks HDT sentences with empty heading fields from a GPS compass without fix.

4: Suppress GPS Pinning

GPS receivers sometimes leave the COG and SOG fields of the RMC sentence empty when the position is stationary. Some devices receiving such sentences consider this as an error. When this option is enabled, the multiplexer will detect these empty fields and fill them with "0.0".

5: Transmit TAG Blocks

Prepend each NMEA sentence transmitted from the host interface with a source TAG block, This TAG block identifies the NMEA 0183 input number or the NMEA 2000 Source Address of the sentence.

6: NMEA 0183 V1.5 Output

Enables conversion from NMEA 0183 V2.0 (and higher) to V1.5 sentences for NMEA Out2. The following sentences are converted: APB, BWC, BWR, GGA, GLL, HDG, RMA, RMB, RMC, VBW, VLW, VTG, XTE and ZDA.

A HDG sentence is converted into a HDM sentence. The heading and COG fields of HDM and VTG sentences respectively are truncated to remove any decimals.

7: Enable Modbus conversion

Switches NMEA Out2 to an RS485 Modbus RTU master port. All routing of NMEA 0183 to Out2 is disabled.

8: Enable Modbus Error reports

Enables transmission of \$PSMDB,D,... and \$PSMDB,E,... sentences in case of errors on the Modbus RS485 network.

10: Enable Metric SeaTalk Depth

This option will instruct any SeaTalk (repeater) display to show depth in meters instead of feet.

11: No Divisor on NMEA Out2

Disables the sentence divisor for sentences routed to NMEA Out2. The sentence divisor is still applied to (the same) sentences routed to NMEA Out1.

12: Generate GNSS Data from AIS Own Ship Information

This option generates GGA, GLL, RMC and VTG sentences as well as GNSS PGN's when AIS Own Ship information is received from NMEA 0183 or NMEA 2000.

13: Generate NMEA 0183 GNSS sentences from NMEA 0183 sources

This option generates NMEA 0183 GNSS sentences from all sources, including NMEA 0183 sources. This can be used for instance to generate GGA, GLL, VTG and ZDA if only RMC is received, or an RMC sentence if only GGA/GLL, VTG and ZDA are received.

14: Enables Modbus Slave mode

This option switches the Modbus engine to slave mode. Currently only small array of holding registers is served, without any function.

\$PSMDOV – Overflow

This sentence is transmitted when more NMEA sentences are routed to an output (Out1 and Out2) than its queue can hold. In MPXConfig3Pro, this will be indicated by two blinking red indicators, one for each output. The red LED on the multiplexer will blink too.

Format: \$PSMDOV,xx*hh<CR><LF>

xx: Hexadecimal field. This is a hexadecimal number where each bit represents an NMEA output. The following bits are defined:

- 0: NMEA Out1
- 1: NMEA Out2
- 2: NMEA Out3
- 3: NMEA Out4

\$PSMDPR – Priority

Set the priority of the NMEA inputs.

Format: \$PSMDPR, a, x, x, x, x, x, x, x, x, x, x*hh<CR><LF>

a: Sentence Status flag:

- C = sentence is a command to change settings
- R = sentence is a status report of current settings

x: Priority field for input 1 to 8 and NMEA 2000

When similar sentences are received on multiple inputs, the priority of an input is used to determine if a sentence should be forwarded or blocked. Priority values range from 1 to 255 in descending order (1: highest). A 0 disables any priority checks on that input.

\$PSMDRESET – Reset the multiplexer

This sentence resets the multiplexer and starts the bootloader. When a '1' is given as parameter, the factory settings of the multiplexer are restored.

Format: \$PSMDRESET, x*hh<CR><LF>

x: Optional parameter to specify an action while resetting

- 1: restore the multiplexer to its factory settings

After a reset, the multiplexer transmits a \$PSMDLDR sentence and a \$PSMDVER sentence on the host interface.

\$PSMDRTE – Set Route

This sentence adds an entry into the routing table. Routes are specified using the address field of an NMEA sentence. For each route, the input(s) or NMEA 2000 device from which the sentence may be received must be specified. Optionally, a divisor and an output routing field can be added. NMEA 2000 devices are identified by their NAME, which is the contents of their Address Claim Message (PGN 60928). A sentence for which no routing entry exists is forwarded according to the default route or blocked. This depends on the routing mode set by Option 0 (see \$PSMDOP sentence).

Format: \$PSMDRTE, C, ccccc, xxxx, dd, yy, s--s*hh<CR><LF> (*command*)
\$PSMDRTE, R, ccccc, xxxx, dd, yy, s--s, sa*hh<CR><LF> (*report*)

ccccc: Address field for the route (e.g. 'GPRMC', 'IIMWV', etc.). This field may contain wildcard characters ('-'). For instance, 'GP---' will apply to all sentences starting with 'GP'. Similarly, '--MWV' will apply to all sentences ending on 'MWV' regardless of the Talker ID. Multiple entries with the same address field are accepted to route similar sentences from different inputs to different outputs.

xxxx: Input field. This is a hexadecimal number where each bit represents an NMEA input. The following bits are defined:

- 0: NMEA In1
- 1: NMEA In2
- 2: NMEA In3
- 3: NMEA In4
- 4: NMEA In5
- 5: NMEA In6
- 6: NMEA In7
- 7: NMEA In8
- 8: NMEA Conversions
- 9: Host input
- 15: NMEA 2000

When a bit is 1, the sentence is forwarded, otherwise the sentence is blocked from that input.

dd: Optional divisor factor (0..99). The rate or frequency of a sentence is divided by this number to reduce the number of sentences over time. If for instance a divisor of 5 is specified, only every 5th occurrence of this sentence is forwarded. The divisor is only applied to sentences which are routed to NMEA Out1 and NMEA Out2. The host interface will always transmit sentences at their original rate.

yy: Optional routing field, setting the destination of the sentence. This is a hexadecimal number where each bit represents an output. The following bits are defined:

- 0: NMEA Out1
- 1: NMEA Out2
- 2: NMEA Out3
- 3: NMEA Out4
- 4: SeaTalk bus
- 6: Host output

When a bit is 1, the sentence is routed to that output.

s--s: Optional NAME, (16 hexadecimal digits) identifying an NMEA 2000 source. Only processed and stored if the NMEA 2000-bit is set in the input (xx) field.

sa: Optional Source Address from an NMEA 2000 source. This field only exists in a report sentence.

hh: Optional checksum

A \$PSMDRTE sentence with the word DELETE in the 'ccccc' field deletes all routes. The multiplexer will respond with a \$PSMDRDY sentence. This also indicates the start of a time window of 200ms during which new \$PSMDRTE sentences are accepted to define new routes. Each received \$PSMDRTE sentence restarts this window. When the last \$PSMDRTE sentence is received, the window will eventually time out and the multiplexer will store the received routes in non-volatile memory. When the routes are stored, the multiplexer will respond again with a \$PSMDRDY sentence.

The multiplexer will ignore new routes when the window has timed out or when then maximum number of 50 routes is reached.

Example:

```
$PSMDRTE,C,HEHDT,0018,5,05<CR><LF>
```

This sentence specifies a route for all sentences that have 'HEHDT' in the address field. It only passes \$HEHDT sentences from inputs 3 and 4, the rate/frequency is reduced by 5 and the sentence is routed to NMEA Out1 and the host only.

When the routing table is requested, the multiplexer responds by sending \$PSMDRTE sentences, one for each entry. A \$PSMDRDY sentence marks the end of the list.

Example response:

```
$PSMDRTE,R,GPRMC,0009,,20,,*3E<CR><LF>  
$PSMDRTE,R,GPGGA,8000,,21,C632820022220839,213*6F<CR><LF>  
$PSMDRTE,R,WIMWV,8000,,20,C03287004A600A23,5*6D<CR><LF>  
$PSMDRTE,R,GPGSV,0001,,20,,*28<CR><LF>  
$PSMDRDY*45<CR><LF>
```

The sentences may not be transmitted as one contiguous block. In case of much NMEA data, they may be interspersed with other NMEA sentences.

\$PSMDSP – Set Speed

This sentence sets the baudrate of the NMEA inputs and outputs.

Format: \$PSMDSP,a,b,c,d,e,f,g,h,i,j,k,l[*hh]<CR><LF>

The following fields are defined for setting the various inputs and outputs:

- a: Sentence Status flag:
 - C = sentence is a command to change settings
 - R = sentence is a status report of current settings
- b: NMEA In1
- c: NMEA In2
- d: NMEA In3/Out3
- e: NMEA In4
- f: NMEA In5
- g: NMEA In6
- h: NMEA In7
- i: NMEA In8
- j: NMEA Out1
- k: NMEA Out2
- l: NMEA Out4/Modbus

Valid field values are:

- 0 = 4800 Baud
- 1 = 9600 Baud
- 2 = 19200 Baud
- 3 = 38400 Baud
- 4 = 57600 Baud
- 5 = 115200 Baud

Field b is ignored when In1 is set to SeaTalk.

\$PSMDST – SeaTalk Data

This sentence transports raw SeaTalk data. It is transmitted by the multiplexer when options 1 *and* 2 or option 2 are enabled.

Format: \$PSMDST,a,xx,xx,xx,...,xx[*hh]<CR><LF>

a: Sentence Status flag:

- C = sentence is a command to transmit SeaTalk data
- R = sentence contains received SeaTalk data

xx: hexadecimal value of a SeaTalk datagram byte, 3 to 18 bytes.

When the MiniPlex-3PRO receives this sentence through a host interface while SeaTalk is enabled, a SeaTalk datagram will be generated with this data and transmitted on the SeaTalk network.

\$PSMDUI – Set Unique Identifier

Sets the Unique Identifier (UI) of the multiplexer. This UI is sent as source parameter in TAG blocks sent by the multiplexer.

Format: \$PSMDUI,a,c--c*hh<CR><LF>

a: Sentence Status flag:

- C = sentence is a command to change settings
- R = sentence is a status report of current settings

c--c: Unique Identifier, maximum 12 characters. If this field exceeds the maximum character count, is not present, or empty, the UI is reset to "MXnn" where "nn" are the last two digits of the serial number of the multiplexer.

\$PSMDVER – Get Version

This sentence retrieves version information from the multiplexer.

Format: \$PSMDVER

The multiplexer responds with the following version sentence:

\$PSMDVER,3.2.0,MiniPlex-3PRO,3C000943,A03C*hh<CR><LF>

3.2.0: firmware version number

MiniPlex-3PRO: multiplexer name

3C000943: serial number

A03C: Multiplexer capabilities. This is a 4 digit, 16-bit field represented as a hexadecimal number. Each bit identifies a capability of the multiplexer. The following bits are defined:

- 2-0: Host interface type, 0: serial, 1: USB, 2: Ethernet, 3: USB + WiFi, 4: Ethernet (3PRO)
- 3: SeaTalk transmission supported
- 4: NMEA 2000 supported
- 5: MiniPlex-3PRO
- 15-13: Multiplexer generation: 5 = 4th generation

hh: checksum

\$PSMDXDR – Specify Transducer ID

This sentence specifies the Transducer ID for a conversion from an XDR sentence to NMEA 2000.

Format: \$PSMDXD,a,x,c--c*hh<CR><LF>

a: Sentence Status flag:

C = sentence is a command to change settings

R = sentence is a status report of current settings

x: Conversion ID:

0: Mast angle to PGN 65330

1: Sailing performance to PGN 127488, field 2 – Engine Speed

c--c: Transducer ID, 15 characters max.

Example:

```
$PSMDXD,C,0,mastangle
```

This command will enable the conversion for mast angle. The MiniPlex-3PRO will search for Transducer ID "mastangle" in every XDR sentence it receives and converts this angle to PGN 65330. The received XDR sentence may also contain other sensor data.

To disable this conversion, send command

```
$PSMDXD,C,0
```

Proprietary NMEA 0183 Sentences – NMEA 2000

\$PSMDNA – Set NMEA 2000 Source Address

This sentence sets the NMEA 2000 Source Address of each virtual NMEA 2000 device of the multiplexer.

Format: \$PSMDNA,a,b,c,d,e,f,g,h,i,j,k*hh<CR><LF>

- a: Sentence Status flag:
 - C = sentence is a command to change settings
 - R = sentence is a status report of current settings
- b: Source Address of Main (System and Host interfaces)
- c: Source Address of NMEA 0183 In1
- d: Source Address of NMEA 0183 In2
- e: Source Address of NMEA 0183 In3
- f: Source Address of NMEA 0183 In4
- g: Source Address of NMEA 0183 In5
- h: Source Address of NMEA 0183 In6
- i: Source Address of NMEA 0183 In7
- j: Source Address of NMEA 0183 In8
- k: Source Address of NMEA 0183 conversions

Note that when this command is executed, the specified addresses will be requested using the NMEA 2000 Address Claim Procedure. If other devices on the NMEA 2000 network have already claimed one of these addresses, the Address Claim Procedure determines who "wins" the specified address. So, the addresses claimed by the MiniPlex may eventually be different.

\$PSMDNC – ISO Address Claim Message/ISO Command Address

This sentence is transmitted from the host interface when the MiniPlex receives an NMEA 2000/ISO Address Claim Message (PGN 60928) from another device on the NMEA 2000 network. This sentence is also used to command a Source Address to another device on the NMEA 2000 network.

Format: \$PSMDNC,a,x--x,sa*hh<CR><LF>

- a: Sentence Status flag:
 - C = sentence is a command to change the Source Address of a device on the NMEA 2000 network.
 - R = sentence contains the Address Claim Message of a device on the NMEA 2000 network.
- x--x: The NAME of the device receiving or claiming the Source Address, a 16-digit hexadecimal number.
- sa: Source Address of the device receiving or claiming the Source Address.

\$PSMDND – Set NMEA 2000 Device Instance

This sentence sets the NMEA 2000 Device Instance of each virtual NMEA 2000 device of the multiplexer.

Format: \$PSMDND,a,b,c,d,e,f,g,h,i,j,k*hh<CR><LF>

- a: Sentence Status flag:
 - C = sentence is a command to change settings
 - R = sentence is a status report of current settings
- b: Device Instance of Main (System and Host interfaces)
- c: Device Instance of NMEA 0183 In1
- d: Device Instance of NMEA 0183 In2
- e: Device Instance of NMEA 0183 In3
- f: Device Instance of NMEA 0183 In4
- g: Device Instance of NMEA 0183 In5
- h: Device Instance of NMEA 0183 In6
- i: Device Instance of NMEA 0183 In7
- j: Device Instance of NMEA 0183 In8
- k: Device Instance of NMEA 0183 conversions

\$PSMDNF – Set NMEA 2000 Class and Function Code

This sentence sets the NMEA 2000 Device Class and Device Function of each virtual NMEA 2000 device of the multiplexer.

Format: \$PSMDNF,a,b,c,d,e,f,g,h,i,j,k*hh<CR><LF>

a: Sentence Status flag:

- C = sentence is a command to change settings
- R = sentence is a status report of current settings

b: Class and Function of Main (System and Host interfaces)

c: Class and Function of NMEA 0183 In1

d: Class and Function of NMEA 0183 In2

e: Class and Function of NMEA 0183 In3

f: Class and Function of NMEA 0183 In4

g: Class and Function of NMEA 0183 In5

h: Class and Function of NMEA 0183 In6

i: Class and Function of NMEA 0183 In7

j: Class and Function of NMEA 0183 In8

k: Class and Function of NMEA 0183 conversions

The Device Class and Device Function is set by a single number. Each number defines a combination of Device Class and Device Function as shown in the table below:

Num	Class	Function	Name
0	25	135	NMEA 0183 Gateway
1	25	130	PC Gateway
2	60	195	AIS
3	70	140	AIS (< V2)
4	40	150	Autopilot
5	60	130	Depth
6	60	135	Depth & Speed
7	120	130	Display/User Interface/Plotter
8	70	150	DSC (< V2)
9	60	205	ECDIS (< V2)
10	60	210	ECS (< V2)
11	20	130	EPIRB
12	70	130	EPIRB (< V2)
13	80	160	General Purpose Display (< V2)
14	40	160	Heading (< V2)
15	60	140	Ownship Attitude
16	80	150	Integrated Instruments (< V2)
17	60	170	Integrated Navigation (< V2)
18	60	175	Integrated Navigation System
19	20	135	Man Overboard
20	70	180	MF/HF Radio (< V2)
21	60	145	Ownship Position (GNSS)
22	60	150	Ownship Position (Loran C)
23	60	200	Radar
24	40	155	Rudder
25	70	170	Satellite Communications
26	60	155	Speed
27	60	160	Turn Rate (< V2)
28	70	190	VHF Radio with DSC
29	20	140	Voyage Data Recorder
30	80	140	Voyage Data Recorder (< V2)
31	85	160	Water Temperature
32	80	180	Weather Instrument (< V2)
33	85	130	Wind/Pressure/Humidity

\$PSMDNI – Command Device and System Instance

This sentence commands the Device and/or System Instance of another device on the NMEA 2000 network.

Format: \$PSMDNI, a, b, c*hh<CR><LF>

- a: Source Address of device on the NMEA 2000 network
- b: Device Instance to be commanded to the remote device
- c: System Instance to be commanded to the remote device

When the remote device acknowledges the commanded parameters, the multiplexer will transmit a \$PSMDACK sentence containing the acknowledgement status values for each parameter that is modified on the remote device.

\$PSMDNM – Set Manufacturer Code

This sentence sets the NMEA 2000 Manufacturer Code of each virtual NMEA 2000 device of the multiplexer.

This command should be used with care because it violates the NMEA 2000 certification of the MiniPlex-3PRO.

Some older NMEA 2000 devices only receive data from other devices from the same manufacturer. These devices will not list a MiniPlex-3PRO NMEA 0183 input as a Data Source. By setting the Manufacturer Code of an NMEA 0183 input of the MiniPlex-3PRO to the Manufacturer Code of this receiving device, it will then list and accept this input as a Data Source. A good example of such a device is the Lowrance LMF-200, a gauge for engine data which is also capable of showing NMEA parameters such as Water Speed, Depth or GNSS Position. The MF-200 however, will only show other Lowrance devices in its Device List and accept data from Lowrance devices.

Format: \$PSMDNM, a, b, c, d, e, f, g, h, i, j, k, *hh<CR><LF>

- a: Sentence Status flag:
 - C = sentence is a command to change settings
 - R = sentence is a status report of current settings
- b: Manufacturer Code of Main (System and Host interfaces)
- c: Manufacturer Code of NMEA 0183 In1
- d: Manufacturer Code of NMEA 0183 In2
- e: Manufacturer Code of NMEA 0183 In3
- f: Manufacturer Code of NMEA 0183 In4
- g: Manufacturer Code of NMEA 0183 In1
- h: Manufacturer Code of NMEA 0183 In2
- i: Manufacturer Code of NMEA 0183 In3
- j: Manufacturer Code of NMEA 0183 In4
- k: Manufacturer Code of NMEA 0183 conversions

\$PSMDNO – Set NMEA 2000 Options

This sentence enables or disables NMEA 2000 options.

Format: \$PSMDNO, a, o, e*hh<CR><LF> *(command only)*
or: \$PSMDNO, a, xxxxxxxx*hh<CR><LF> *(command and report)*

- a: Sentence Status flag:
 - C = sentence is a command to change settings
 - R = sentence is a status report of current settings

o: option number

- e: 0 = off/disable
- 1 = on/enable

xxxxxxx: all options at once as a 32-bit hexadecimal number. Each bit represents an option where bit 0 is option 0, bit 1 is option 1 etc.

Example: \$PSMDNO, C, 6, 1<CR><LF> *(enables option 6)*
\$PSMDNO, C, 0000021<CR><LF> *(enables options 5 and 0)*

The following options are implemented:

- 0: Enable RMC sentence from a GPS source (enabled by default)
- 1: Enable GGA sentence from a GPS source

- 2: Enable GLL sentence from a GPS source
- 3: Enable VTG sentence from a GPS source
- 4: Enable GSA and GSV sentences from a GPS source
- 5: Enable RMB sentence from a navigation source (enabled by default)
- 6: Enable APB sentence from a navigation source
- 7: Enable XTE sentence from a navigation source
- 8: Enable BWC or BWR sentences from a navigation source
- 9: Transmit system time using a \$--ZDA sentence and PGN 126992
- 10: Transmit a DBT sentence instead of DPT from a water septh source
- 11: Transmit GNSS sentences (GGA, GLL, RMC and VTG) at 10 Hz
- 12: Transmit \$PFEC,Att and \$PFEC,Hve sentences instead of \$YXXDR from attitude and heave sources
- 13: Enable ZTG sentence from a navigation source
- 14: Transmit speed sentences (VBW, VHW) at 10 Hz
- 15: Transmit MDA sentence
- 16: Transmit THS sentence instead of HDT from a true heading source
- 29: Disable transmission of the Main device (Host interface) on the NMEA 2000 network
- 30: Transmit unknown NMEA 2000 PGN's as an \$MXPGN sentence
- 31: Transmit all NMEA 2000 PGN's as an \$MXPGN sentence. Enabling this option inhibits all conversions to NMEA 0183 as well as filling the NMEA 2000 Device List in MPX-Config3

\$PSMDNP – NMEA 2000 Product Information

This sentence is transmitted by the host interface when the MiniPlex receives an NMEA 2000 Product Information PGN (126996) in response of command \$PSMDNR. Each request results in three \$PSMDNP sentences with a different format. Each of these sentences is identified with an identifier character in the first field.

Format: \$PSMDNP,A,sa,v,pc,c,l*hh<CR><LF>

- sa: Source Address of the Product Information
- v: NMEA 2000 Message Version (field 1 of PGN 126996)
- pc: Manufacturer's Product Code (field 2 of PGN 126996)
- c: NMEA 2000 Certification Level (field 7 of PGN 126996)
- l: Load Equivalency of the device (field 8 of PGN 126996)

Format: \$PSMDNP,B,mod,ser*hh<CR><LF>

- mod: Manufacturer's Model ID (field 3 of PGN 126996)
- ser: Manufacturer's Serial Code(field 6 of PGN 126996)

Format: \$PSMDNP,C,sv,mv*hh<CR><LF>

- sv: Manufacturer's Software Version Code (field 4 of PGN 126996)
- mv: Manufacturer's Model Version (field 5 of PGN 126996)

\$PSMDNR – NMEA 2000 PGN Request

This sentence requests a PGN from an NMEA 2000 device.

Format: \$PSMDNR,p,s*hh<CR><LF>

- p: PGN to request.
- s: Source Address to send the request to. If omitted or set to 255, the request is sent as a global request.

The MiniPlex-3PRO will listen for a response to this request for 1.25 s (standard ISO response timeout).

\$PSMDNS – Set NMEA 2000 System Instance

This sentence sets the NMEA 2000 System Instance of each virtual NMEA 2000 device of the multiplexer.

Format: \$PSMDND,a,b,c,d,e,f,g,h,i,j,k*hh<CR><LF>

- a: Sentence Status flag:
 - C = sentence is a command to change settings
 - R = sentence is a status report of current settings
- b: System Instance of Main (System and Host interfaces)
- c: System Instance of NMEA 0183 In1
- d: System Instance of NMEA 0183 In2
- e: System Instance of NMEA 0183 In3
- f: System Instance of NMEA 0183 In4
- g: System Instance of NMEA 0183 In5
- h: System Instance of NMEA 0183 In6
- i: System Instance of NMEA 0183 In7
- j: System Instance of NMEA 0183 In8
- k: System Instance of NMEA 0183 conversions

Technical Specifications

Supply voltage:	8 – 35 V _{DC} , protected against reversed polarity.
Current consumption:	120 mA (180 mA max. with fully loaded talker ports)
Host interface:	10BASE-T/100BASE-TX Ethernet
Supported protocols:	TCP/IP and UDP, port 10110 for NMEA communication TCP/IP, port 10110 for firmware updates TCP/IP and UDP, port 30718 for network configuration ARP, ICMP and DCHP for network management
Inputs:	8 x NMEA 0183/RS-422, galvanically isolated. Input 1 can be set to SeaTalk mode
Input resistance:	>1.4 kOhm
Input current:	0.5mA @ 2V 3.0mA @ 5V 7.1mA @ 10V
Outputs:	4 x NMEA 0183/RS-422, galvanically isolated.
Max output current:	20mA @ >2V
Routing table size:	50 sentence types
Priority table size:	50 sentence types
Speed NMEA inputs:	4800 - 115200 Baud
Speed NMEA outputs:	4800 - 115200 Baud
Indicators:	Overflow and Data
Dimensions:	146 x 94 x 34 mm
Housing:	Flame retardant ABS.
NMEA 2000 Port:	LEN: 1 Speed: 250kbps
NMEA 2000 Manufacturer Code:	595
NMEA 2000 Product Code:	22615
Connector:	4-pole screw terminal

Contact Information

ShipModul B.V.
Noorderstaete 34a
9402 XB Assen
The Netherlands

Tel: +31 592 375700

Fax: +31 592 375550

www: www.shipmodul.com

e-mail: support@shipmodul.com